

Finley Woods Community Development District

3501 Quadrangle Boulevard, Suite 270, Orlando, FL 32817; 407-723-5900

<http://finleywoodscdd.com/>

The following is the proposed agenda for the Board of Supervisors Meeting for the Finley Woods Community Development District, scheduled to be held **Thursday, February 12, 2026, at 11:00 a.m. at the Offices of Tommy Williams Homes located at 2563 SW 87th Drive, Suite 10, Gainesville, FL 32608.** The attendance of three Board Members is required to constitute a quorum. Questions or comments on the Board Meeting or proposed agenda may be addressed to Jane Gaarlandt at gaarlandtj@pfm.com or (407) 723-5900.

To attend the meetings by phone, please use the below conference call information:

Phone: **1-844-621-3956**

Access Code: **2539 895 0958**

BOARD OF SUPERVISORS' MEETING AGENDA

Administrative Matters

- Roll Call to Confirm Quorum
 - Public Comment Period *[for any member of the public desiring to speak on any proposition before the Board]*
1. **Consideration of Minutes of the November 12, 2025, Board of Supervisors' Meeting**

Business Matters

2. **Consideration of Agreement between the District and Grasshopper TLC for Landscape Maintenance**
3. **Discussion regarding Phase 1C Common Area Maintenance**
 - **Request For Repair Work**
4. **Ratification of Additional Phase 1C Pond Cleanup Proposal with Grasshopper TLC**
5. **Ratification of Phase 3 O&M Certification of Financial Capability**
 - **Drainage Rights from Finley Woods CDD to discharge to Finley Woods Phase 2 Stormwater Pond** *(provided under separate cover)*
6. **Consideration of Work Product Acquisition for the Series 2020 Project**
 - A. **Resolution 2026-01, Authorizing DSRF Release and Requisition (Series 2020)**
7. **Consideration of Funding Request Nos. 93 - 100**
8. **Review of Monthly Financials**

Other Business

Staff Reports

District Counsel
District Engineer
District Manager

- **Next Meeting March 12, 2026**

Developer Updates

**Supervisor Requests and Audience Comments
Adjournment**





Finley Woods Community Development District

**Consideration of Minutes of the
November 12, 2025,
Board of Supervisors' Meeting**

MINUTES OF MEETING

**FINLEY WOODS COMMUNITY DEVELOPMENT DISTRICT
BOARD OF SUPERVISORS' MEETING**

Wednesday, November 12, 2025, at 11:00 a.m.

**Offices of Tommy Williams Homes
2563 SW 87th Drive, Suite 10
Gainesville, FL 32608**

Board Members present at roll call:

Ginney Patterson	Chair
Hank Taylor	Assistant Secretary
Cale Rogers	Vice Chair
Tonia Greve	Assistant Secretary

Also Present:

Jane Gaarlandt	PFM Group Consulting LLC	
Gazmin Kerr	PFM Group Consulting LLC	(via phone)
Rick Montejano	PFM Group Consulting LLC	(via phone)
Michelle Rigoni	Kutak Rock	(via phone)
Allyson Aldana	The Boyd Group	
Kelly Burch	Bosshardt	(via phone)

FIRST ORDER OF BUSINESS

Call to Order and Roll Call

Ms. Gaarlandt called the Board of Supervisors Meeting to order at approximately 11:00 a.m. Those in attendance are outlined above.

SECOND ORDER OF BUSINESS

Public Comment Period

There were no public comments.

THIRD ORDER OF BUSINESS

**Review and Consideration of
Resignation Letter from Derek Batsel**

- **Nomination for Vacant Seat 4**
- **Swearing in New Supervisor**

On MOTION by Ms. Patterson, seconded by Mr. Rogers, with all in favor, the Board of Supervisors for the Finley Woods Community Development District accepted the Resignation Letter from Derek Batsel.

Ms. Gaarlandt noted that Seat 4 was now vacant, and the term expires in November of 2026.

On MOTION by Ms. Greve, seconded by Mr. Rogers, with all in favor, the Board of Supervisors for the Finley Woods Community Development District nominated Ms. Aldana to Seat 4.

Ms. Gaarlandt administered the Oath of Office to Ms. Aldana.

Ms. Rigoni gave an overview of the Florida Sunshine Law, Public Records Laws, and Ethics Laws. Any questions can be directed to District Counsel or District Manager.

FOURTH ORDER OF BUSINESS

Consideration of Resolution 2026-02, Election of Officers

There were no public comments at this time.

Ms. Gaarlandt reviewed the current slate of Officers and noted the Board could keep the current slate of officers adding Ms. Aldana as Assistant Secretary and removing Mr. Batsel.

On MOTION by Ms. Greve, seconded by Ms. Patterson, with all in favor, the Board of Supervisors for the Finley Woods Community Development District approved Resolution 2026-02, Election of Officers, keeping the current slate of Officers, removing Mr. Batsel and adding Ms. Aldana as Assistant Secretary.

FIFTH ORDER OF BUSINESS

Consideration of Minutes of the September 23, 2025, Board of Supervisors' Meeting

The Board reviewed the minutes.

On MOTION by Ms. Patterson, seconded by Mr. Rogers, with all in favor, the Board of Supervisors for the Finley Woods Community Development District approved the Minutes of the September 23, 2025, Board of Supervisors' Meeting.

SIXTH ORDER OF BUSINESS

Consideration of Landscape Maintenance Proposals:

- Grasshopper TLC
- Alex Michael Landscaping
- Shortcuts Landscaping
 - Landscape Maintenance Proposal Spreadsheet

Ms. Gaarlandt gave an overview of the proposals from the vendors requested. It was noted Shortcuts Landscaping did not provide a proposal.

There was discussion regarding the proposal costs and scope of services.

Ms. Burch noted the current summer lawncare is on a weekly schedule.

Ms. Gaarlandt noted the standard agreement includes a 30-day termination clause.

On MOTION by Ms. Patterson, seconded by Mr. Rogers, with all in favor, the Board of Supervisors for the Finley Woods Community Development District approved the less expensive second option Proposal from Grasshopper TLC.

There was brief discussion regarding the timing of when the new vendor should start. It was decided to start with the new vendor December 1st. District Management will email Premier Landscaping to terminate the month to month services.

On MOTION by Mr. Rogers, seconded by Ms. Greve, with all in favor, the Board of Supervisors for the Finley Woods Community Development District approved Grasshopper TLC to begin landscaping starting December 1, 2025, with authorization for the Chair or Vice Chair to execute the final Agreement.

Ms. Patterson commented regarding the Phase C retention pond clean-up work. Ms. Gaarlandt noted the vendor just completed the clean-up.

SEVENTH ORDER OF BUSINESS

**Consideration of Work Product
Acquisition for the Series 2020 Project
A. Resolution 2026-01,
Authorizing DSRF Release
and Requisition (Series 2020)**

This item was deferred.

EIGHTH ORDER OF BUSINESS

**Consideration of Funding Request No.
91-92**

The Board reviewed the funding requests.

There was brief discussion regarding the insurance budgeted amount and actual cost. It was noted it was within budget.

On MOTION by Ms. Patterson, seconded by Mr. Rogers, with all in favor, the Board of Supervisors for the Finley Woods Community Development District approved Funding Request No. 91-92.

NINTH ORDER OF BUSINESS

Review of Monthly Financials

The Board reviewed the monthly financials as of September 2025.

On MOTION by Mr. Rogers, seconded by Ms. Patterson, with all in favor, the Board of Supervisors for the Finley Woods Community Development District accepted the Monthly Financials.

TENTH ORDER OF BUSINESS

Other Business

Staff Reports

District Counsel – No Report.

District Engineer – No Report.

District Manager – Ms. Gaarlandt noted the next Board meeting is scheduled for December 2, 2025. The Board agreed to cancel this meeting.

There was brief discussion regarding the District's meeting schedule. The Board agreed to move meetings to the second Thursday of the month, at 11:00 a.m. Meetings can be adjusted as needed.

On MOTION by Mr. Rogers, seconded by Ms. Patterson, with all in favor, the Board of Supervisors for the Finley Woods Community Development District approved the Fiscal Year 2026 Annual Meeting Schedule, with meetings being held the second Thursday of each month, at 11:00 a.m. at the current location.

There was brief discussion regarding the Phase 3 financing and the Developer Representative position. It was noted there will be a Developer's update item on the agenda moving forward, but a representative position will not be needed.

Ms. Gaarlandt gave an overview of the FY 25 Goals and Objectives Report. She noted it will be posted on the District's website once accepted and executed by the Chair.

On MOTION by Ms. Patterson, seconded by Mr. Rogers, with all in favor, the Board of Supervisors for the Finley Woods Community Development District accepted the FY 2025 Goals and Objectives Report.

ELEVENTH ORDER OF BUSINESS

Supervisor Requests and Audience Comments

There were no further Supervisor requests or audience comments.

TWELFTH ORDER OF BUSINESS

Adjournment

On MOTION by Ms. Patterson, seconded by Mr. Rogers, with all in favor, the Board of Supervisors for the Finley Woods Community Development District adjourned the November 12, 2025, Board of Supervisors' Meeting.

Secretary / Assistant Secretary

Chairperson/Vice Chairperson



Finley Woods Community Development District

**Consideration of Agreement between the
District and Grasshopper TLC for Landscape
Maintenance**

AGREEMENT FOR LANDSCAPE MAINTENANCE SERVICES

THIS AGREEMENT (the "Agreement") is made and entered into this 1st day of December 2025, by and between:

Finley Woods Community Development District, a local unit of special-purpose government established pursuant to Chapter 190, *Florida Statutes*, whose mailing address is 3501 Quadrangle Boulevard, Suite 270, Orlando, Florida 32817 (the "District"); and

Grasshoppers Total Lawn Care, LLC, a Florida limited liability company, whose address is 661 SW 161st Terrace, Newberry, Florida 32669 (the "Contractor").

RECITALS

WHEREAS, the District was established pursuant to Chapter 190, *Florida Statutes*, for the purpose of planning, financing, constructing, operating and/or maintaining certain infrastructure improvements, including but not limited to, landscaping improvements; and

WHEREAS, the District desires to enter into an agreement with an independent contractor to provide landscape maintenance services for certain lands within and around the District; and

WHEREAS, Contractor, who submitted the proposals in **Composite Exhibit A** and incorporated by reference herein, represents that it has the skills, knowledge and ability to provide such landscape maintenance services to the District in accordance with the terms of this Agreement; and

WHEREAS, the District and Contractor warrant and agree that they have all right, power, and authority to enter into and be bound by this Agreement.

NOW, THEREFORE, based upon good and valuable consideration and the mutual covenants of the District and Contractor, the receipt of which and sufficiency of which is hereby acknowledged, the Parties agree as follows:

Section 1. Recitals. The recitals so stated are true and correct and by this reference are incorporated into and form a material part of this Agreement.

Section 2. DESCRIPTION OF WORK AND SERVICES.

A. The District desires that Contractor provide professional landscape and irrigation maintenance services within presently accepted standards. Upon all Parties signing this Agreement, Contractor shall provide the District with the Services identified in **Composite Exhibit A**.

B. While providing the Services, Contractor shall assign such staff as may be required, and such staff shall be responsible for coordinating, expediting, and controlling all aspects to assure completion of the Services.

C. Contractor shall provide the Services as shown in **Section 3** of this Agreement. Contractor shall solely be responsible for the means, manner and methods by which its duties, obligations and

responsibilities are met to the satisfaction of the District.

D. This Agreement grants to Contractor the right to enter the lands that are subject to this Agreement, for those purposes described in this Agreement, and Contractor hereby agrees to comply with all applicable laws, rules, and regulations.

SECTION 3. SCOPE OF LANDSCAPE AND IRRIGATION MAINTENANCE SERVICES. Contractor shall provide landscape and irrigation maintenance services for certain lands within the District, specifically identified in **Exhibit B** attached hereto ("**Maintenance Map**"). The duties, obligations, and responsibilities of Contractor are to provide the material, tools, skill and labor necessary for the Services attached as **Exhibit A** on a monthly basis. To the extent any of the provisions of this Agreement conflict with the provisions of the attached Exhibits, this Agreement shall control.

SECTION 4. MANNER OF CONTRACTOR'S PERFORMANCE. Contractor agrees, as an independent contractor, to undertake work and/or perform such Services as specified in this Agreement or any amendment or addendum executed by the Parties or in any authorized written work order by the District issued in connection with this Agreement and accepted by Contractor. All work shall be performed in a neat and professional manner reasonably acceptable to the District and shall be in accordance with industry standards. The performance of the Services by Contractor under this Agreement and related to this Agreement shall conform to any written instructions issued by the District.

A. Should any work and/or services be required which are not specified in this Agreement or any addenda, but which are nevertheless necessary for the proper provision of services to the District, such work or services shall be fully performed by Contractor as if described and delineated in this Agreement.

B. Contractor agrees that the District shall not be liable for the payment of any work or services not included in **Section 3** unless the District, through an authorized representative of the District, authorizes Contractor, in writing, to perform such work.

C. The District shall designate in writing a person to act as the District's representative with respect to the services to be performed under this Agreement. The District's representative shall have complete authority to transmit instructions, receive information, interpret and define the District's policies and decisions with respect to materials, equipment, elements, and systems pertinent to Contractor's services.

- i.** The District hereby designates the District Manager to act as its representative.
- ii.** Upon request by the District Manager, Contractor agrees to meet with the District's representative to walk the property to discuss conditions, schedules, and items of concern regarding this Agreement.

D. Contractor shall use all due care to protect the property of the District, its residents and landowners from damage. Contractor agrees to repair or replace, to the District's satisfaction, any damage resulting from Contractor's activities and work within twenty-four (24) hours. In the event Contractor does not repair or replace the damage to District's satisfaction, Contractor shall be responsible for reimbursing District for such damages.

Section 5. Compensation.

A. As compensation for the Work, the District agrees to pay Contractor a total of Three Thousand One Hundred Dollars (\$3,100.00) per month, as detailed in **Composite Exhibit A**, unless terminated earlier, as provided in this Agreement.

B. The Contractor shall maintain records conforming to usual accounting practices. As soon as may be practicable at the beginning of each month, the Contractor shall invoice the District for all services performed in the prior month and any other sums due to the Contractor. The District shall pay the invoice amount within thirty (30) days after the invoice date. The Contractor may cease performing services under this Agreement if any payment due hereunder is not paid within thirty (30) days of the invoice date. Each monthly invoice will include such supporting information as the District may reasonably require the Contractor to provide.

C. The District may require, as a condition precedent to making any payment to the Contractor that all subcontractors, material men, suppliers or laborers be paid and require evidence, in the form of lien releases or partial waivers of lien, to be submitted to the District by those subcontractors, material men, suppliers, or laborers, and further require that the Contractor provide an Affidavit relating to the payment of said indebtedness. Further, the District shall have the right to require, as a condition precedent to making any payment, evidence from the Contractor, in a form satisfactory to the District, that any indebtedness of the Contractor, as to services to the District, has been paid and that the Contractor has met all of the obligations with regard to the withholding and payment of taxes, Social Security payments, Workmen's Compensation, Unemployment Compensation contributions, and similar payroll deductions from the wages of employees.

D. the District should desire additional work or services, or to add additional areas to be maintained, Contractor agrees to negotiate in good faith to undertake such additional work or services. Upon successful negotiations, the Parties shall agree in writing to an addendum, addenda, change order or a work authorization to this Agreement. Contractor shall be compensated for such agreed upon additional work or services based upon a payment amount acceptable to the Parties and agreed to in writing.

Section 6. Insurance.

A. The Contractor or any subcontractor performing the Work described in this Agreement shall maintain throughout the term of this Agreement the following insurance:

i. Worker's Compensation Insurance in accordance with the laws of the State of Florida.

ii. Commercial General Liability Insurance covering the Contractor's legal liability for bodily injuries, with limits of not less than One Million and No/100 Dollars (\$1,000,000.00) combined single limit bodily injury and property damage liability, and covering at least the following hazards:

a. Independent Contractors Coverage for bodily injury and property damage in connection with subcontractors' operation.

iii. Employer's Liability Coverage with limits of at least One Million and No/100 Dollars (\$1,000,000.00) per accident or disease.

iv. Automobile Liability Insurance for bodily injuries in limits of not less than One Million and No/100 Dollars (\$1,000,000.00) combined single limit bodily injury and for property damage, providing coverage for any accident arising out of or resulting from the operation, maintenance, or use by the Contractor of any owned, non-owned, or hired automobiles, trailers, or other equipment required to be licensed.

B. The District, its staff, consultants and supervisors shall be named as an additional insured. The Contractor shall furnish the District with the Certificate of Insurance evidencing compliance with this requirement. No certificate shall be acceptable to the District unless it provides that any change or termination within the policy periods of the insurance coverage, as certified, shall not be effective within thirty (30) days of prior written notice to the District. Insurance coverage shall be from a reputable insurance carrier, licensed to conduct business in the State of Florida, and such carrier shall have a Best's Insurance Reports rating of at least A-VII.

C. If the Contractor fails to have secured and maintained the required insurance, the District has the right (without any obligation to do so, however), to secure such required insurance in which event, the Contractor shall pay the cost for that required insurance and shall furnish, upon demand, all information that may be required in connection with the District obtaining the required insurance.

Section 7. Independent Contractor. The District and Contractor agree and acknowledge that Contractor shall serve as an independent contractor of the District. Neither the Contractor nor employees of the Contractor, if there are any, are employees of the District under the meaning or application of any Federal or State Unemployment or Insurance Laws or Old Age Laws or otherwise. The Contractor agrees to assume all liabilities or obligations imposed by any one or more of such laws with respect to employees of the Contractor, if there are any, in the performance of this Agreement. The Contractor shall not have any authority to assume or create any obligation, express or implied, on behalf of the District and the Contractor shall have no authority to represent the District as an agent, employee, or in any other capacity, unless otherwise set forth in this Agreement.

Section 8. Indemnification.

A. Contractor agrees to defend, indemnify, and hold harmless the District and its officers, agents, professional staff, successors, assigns, members, affiliates, or representatives from any and all liability, claims, actions, suits, liens, demands, costs, interest, expenses, damages, penalties, fines, judgments against the District, or loss or damage, whether monetary or otherwise, arising out of, wholly or in part by, or in connection with the Services to be performed by Contractor, its subcontractors, its employees and agents in connection with this Agreement, including litigation, mediation, arbitration, appellate, or settlement proceedings with respect thereto. For avoidance of doubt, indemnification obligation of the Contractor herein requires the Contractor to indemnify the District for any and all percentage of fault attributable to Contractor in any claims arising hereunder (whether such claim is against the District, the Contractor or the District and Contractor as jointly liable parties) regardless of whether the District is adjudged to be more or less than 50% at fault. Contractor further agrees that nothing herein shall constitute or be construed as a waiver of the District's limitations on liability contained in section 768.28, Florida Statutes, or other statute.

B. Obligations under this section shall include the payment of all settlements, judgments, damages, liquidated damages, penalties, fines, forfeitures, back pay awards, court costs, arbitration and/or mediation costs, litigation expenses, attorneys' fees, paralegal fees (incurred in court, out of court, on appeal, or in bankruptcy proceedings), any interest accrued against the District, all as actually incurred.

SECTION 9. LIMITATIONS ON GOVERNMENTAL LIABILITY. Nothing in this Agreement shall be deemed as a waiver of the District's sovereign immunity or the District's limits of liability as set forth in section 768.28, *Florida Statutes*, or other statute, and nothing in this Agreement shall inure to the benefit of any third party for the purpose of allowing any claim which would otherwise be barred under such limitations of liability or by operation of law.

SECTION 10. COMPLIANCE WITH GOVERNMENTAL REGULATION. Contractor shall keep, observe, and perform all requirements of applicable local, State, and Federal laws, rules, regulations, or ordinances. If Contractor fails to notify the District in writing within five (5) days of the receipt of any notice, order, required to comply notice, or a report of a violation or an alleged violation, made by any local, State, or Federal governmental body or agency or subdivision thereof with respect to the services being rendered under this Agreement or any action of Contractor or any of its agents, servants, employees, or materialmen, or with respect to terms, wages, hours, conditions of employment, safety appliances, or any other requirements applicable to provision of services, or fails to comply with any requirement of such agency within five (5) days after receipt of any such notice, order, request to comply notice, or report of a violation or an alleged violation, the District may terminate this Agreement, such termination to be effective upon the giving of notice of termination.

SECTION 11. LIENS AND CLAIMS. Contractor shall promptly and properly pay for all labor employed, materials purchased, and equipment hired by it to perform under this Agreement. Contractor shall keep the District's property free from any materialmen's or mechanic's liens and claims or notices in respect to such liens and claims, which arise by reason of Contractor's performance under this Agreement, and Contractor shall immediately discharge any such claim or lien. In the event that Contractor does not pay or satisfy such claim or lien within three (3) business days after the filing of notice thereof, the District, in addition to any and all other remedies available under this Agreement, may terminate this Agreement to be effective immediately upon the giving of notice of termination.

SECTION 12. DEFAULT AND PROTECTION AGAINST THIRD-PARTY INTERFERENCE. A default by either Party under this Agreement shall entitle the other to all remedies available at law or in equity, which may include, but not be limited to, the right of damages, injunctive relief, and/or specific performance. The District shall be solely responsible for enforcing its rights under this Agreement against any interfering third party. Nothing contained in this Agreement shall limit or impair the District's right to protect its rights from interference by a third party to this Agreement.

SECTION 13. CUSTOM AND USAGE. It is hereby agreed, any law, custom, or usage to the contrary notwithstanding, that the District shall have the right at all times to enforce the conditions and agreements contained in this Agreement in strict accordance with the terms of this Agreement, notwithstanding any conduct or custom on the part of the District in refraining from so doing; and further, that the failure of the District at any time or times to strictly enforce its rights under this Agreement shall not be construed as having created a custom in any way or manner contrary to the specific conditions and agreements of this Agreement, or as having in any way modified or waived the same.

SECTION 14. SUCCESSORS. This Agreement shall inure to the benefit of and be binding upon the heirs, executors, administrators, successors, and assigns of the Parties to this Agreement, except as expressly limited in this Agreement.

SECTION 15. TERMINATION. The District agrees that Contractor may terminate this Agreement for cause by providing sixty (60) days' written notice of termination to the District stating a failure of the District to perform according to the terms of this Agreement; provided, however, that the District shall be provided a reasonable opportunity to cure any failure under this Agreement. Contractor agrees that the District may terminate this Agreement immediately for cause by providing written notice of termination to Contractor. The District shall provide thirty (30) days' written notice of termination without cause. Upon any termination of this Agreement, Contractor shall be entitled to payment for all work and/or services rendered up until the effective termination of this Agreement, subject to whatever claims or off-sets the District may have against Contractor.

SECTION 16. PERMITS AND LICENSES. All permits and licenses required by any governmental agency directly for the District shall be obtained and paid for by the District. All other permits or licenses necessary for Contractor to perform under this Agreement shall be obtained and paid for by Contractor.

SECTION 17. ASSIGNMENT. Neither the District nor Contractor may assign this Agreement without the prior written approval of the other. Any purported assignment without such approval shall be void.

SECTION 18. HEADINGS FOR CONVENIENCE ONLY. The descriptive headings in this Agreement are for convenience only and shall neither control nor affect the meaning or construction of any of the provisions of this Agreement.

SECTION 19. ENFORCEMENT OF AGREEMENT. A default by either Party under this Agreement shall entitle the other Party to all remedies available at law or in equity. In the event that either the District or Contractor is required to enforce this Agreement by court proceedings or otherwise, then the prevailing Party shall be entitled to recover all fees and costs incurred, including reasonable attorneys' fees and costs for trial, alternative dispute resolution, or appellate proceedings.

SECTION 20. AGREEMENT. This instrument shall constitute the final and complete expression of this Agreement between the Parties relating to the subject matter of this Agreement.

SECTION 21. AMENDMENTS. Amendments to and waivers of the provisions contained in this Agreement may be made only by an instrument in writing which is executed by both the Parties.

SECTION 22. AUTHORIZATION. The execution of this Agreement has been duly authorized by the appropriate body or official of the Parties, the Parties have complied with all the requirements of law, and the Parties have full power and authority to comply with the terms and provisions of this Agreement.

Section 23. Notices. All notices, requests, consents and other communications hereunder (the "Notices") shall be in writing and shall be delivered, mailed by Federal Express or First Class Mail, postage prepaid, to the parties, as follows:

- A. If to Contractor:** Grasshoppers Total Lawn Care, LLC
661 SW 161st Terrace, Newberry, Florida 32669

Attn: _____

B. If to District: Finley Woods Community Development District
3501 Quadrangle Boulevard, Suite 270
Orlando, Florida 32817
Attn: District Manager

With a copy to: Kutak Rock LLP
107 West College Avenue
Tallahassee, Florida 32301
Attn: District Counsel

Except as otherwise provided in this Agreement, any Notice shall be deemed received only upon actual delivery at the address set forth above. Notices delivered after 5:00 p.m. (at the place of delivery) or on a non-business day, shall be deemed received on the next business day. If any time for giving Notice contained in this Agreement would otherwise expire on a non-business day, the Notice period shall be extended to the next succeeding business day. Saturdays, Sundays, and legal holidays recognized by the United States government shall not be regarded as business days. Counsel for the District and counsel for the Contractor may deliver Notices on behalf of the District and the Contractor. Any party or other person to whom Notices are to be sent or copied may notify the Parties and addressees of any change in name or address to which Notices shall be sent by providing the same on five (5) days' written notice to the Parties and addressees set forth in this Agreement.

SECTION 24. THIRD-PARTY BENEFICIARIES. This Agreement is solely for the benefit of the Parties hereto and no right or cause of action shall accrue upon or by reason, to or for the benefit of any third party not a formal Party to this Agreement. Nothing in this Agreement expressed or implied is intended or shall be construed to confer upon any person or corporation other than the Parties hereto any right, remedy, or claim under or by reason of this Agreement or any of the provisions or conditions of this Agreement; and all of the provisions, representations, covenants, and conditions contained in this Agreement shall inure to the sole benefit of and shall be binding upon the Parties hereto and their respective representatives, successors, and assigns.

SECTION 25. CONTROLLING LAW AND VENUE. This Agreement and the provisions contained in this Agreement shall be construed, interpreted, and controlled according to the laws of the State of Florida. Each Party agrees to and consents that the exclusive venue for any litigation arising out of or related to this Agreement shall be in a court of appropriate jurisdiction, in and for Alachua County, Florida.

Section 26. Public Records. The Contractor agrees and understands that Chapter 119, *Florida Statutes*, may be applicable to documents prepared in connection with the services provided hereunder and agrees to cooperate with public record requests made thereunder. In connection with this Agreement, Contractor agrees to comply with all provisions of Florida's public records laws, including but not limited to Section 119.0701, *Florida Statutes*, the terms of which are incorporated herein. Contractor acknowledges that the designated public records custodian for the District is Jane Gaarlandt. Among other requirements, Contractor must:

A. Keep and maintain public records required by the District to perform the service.

B. Upon request from the District's custodian of public records, provide the District with a copy of the requested records or allow the records to be inspected or copied within a reasonable time at a cost that does not exceed the cost provided in Chapter 119, Florida Statutes or as otherwise provided by law.

C. Ensure that public records that are exempt or confidential and exempt from public records disclosure requirements are not disclosed except as authorized by law for the duration of the contract term and following completion of the Agreement if the Contractor does not transfer the records to the District.

D. Upon completion of this Agreement, transfer, at no cost, to the District all public records in possession of the Contractor or keep and maintain public records required by the District to perform the service. If the Contractor transfers all public records to the District upon completion of this Agreement, the Contractor shall destroy any duplicate public records that are exempt or confidential and exempt from public records disclosure requirements. If the Contractor keeps and maintains public records upon completion of the Agreement, the Contractor shall meet all applicable requirements for retaining public records. All records stored electronically must be provided to the District, upon request from the District's custodian of public records, in a format that is compatible with the information technology systems of the District.

IF THE CONTRACTOR HAS QUESTIONS REGARDING THE APPLICATION OF CHAPTER 119, *FLORIDA STATUTES*, TO THE CONTRACTOR'S DUTY TO PROVIDE PUBLIC RECORDS RELATING TO THIS AGREEMENT, CONTACT THE CUSTODIAN OF PUBLIC RECORDS, PFM GROUP CONSULTING LLC, 3501 QUADRANGLE BOULEVARD, SUITE 270, ORLANDO, FLORIDA 32817, (407) 723-5900, GAARLANDTJ@PFM.COM.

SECTION 27. SEVERABILITY. The invalidity or unenforceability of any one or more provisions of this Agreement shall not affect the validity or enforceability of the remaining portions of this Agreement, or any part of this Agreement not held to be invalid or unenforceable.

SECTION 28. ARM'S LENGTH TRANSACTION. This Agreement has been negotiated fully between the Parties as an arm's length transaction. The Parties participated fully in the preparation of this Agreement with the assistance of their respective counsel. In the case of a dispute concerning the interpretation of any provision of this Agreement, the Parties are each deemed to have drafted, chosen, and selected the language, and any doubtful language will not be interpreted or construed against any Party.

SECTION 29. COUNTERPARTS; ELECTRONIC SIGNATURES. This instrument may be executed in any number of counterparts, each of which, when executed and delivered, shall constitute an original, and such counterparts together shall constitute one and the same instrument. Signature and acknowledgment pages, if any, may be detached from the counterparts and attached to a single copy of this document to physically form one document. Additionally, the Parties acknowledge and agree that this Agreement may be executed by electronic signature, which shall be considered as an original signature for all purposes and shall have the same force and effect as an original signature. Without limitation, "electronic

signature” shall include faxed versions of an original signature, electronically scanned and transmitted versions (e.g. via PDF) of an original signature, or signatures created in a digital format.

SECTION 30. STATEMENT REGARDING CHAPTER 287 REQUIREMENTS. Contractor acknowledges that, in addition to all Laws and Regulations that apply to this Agreement, the following provisions of Florida law (“**Public Integrity Laws**”) apply to this Agreement:

- A. Section 287.133, *Florida Statutes*, titled *Public entity crime; denial or revocation of the right to transact business with public entities*;
- B. Section 287.134, *Florida Statutes*, titled *Discrimination; denial or revocation of the right to transact business with public entities*;
- C. Section 287.135, *Florida Statutes*, titled *Prohibition against contracting with scrutinized companies*;
- D. Section 287.137, *Florida Statutes*, titled *Antitrust violations; denial or revocation of the right to transact business with public entities; denial of economic benefits*;
- E. Section 287.138, *Florida Statutes*, titled *Contracting with entities of foreign countries of concern prohibited*; and
- F. Section 787.06, *Florida Statutes*, titled *Human Trafficking*.

Contractor acknowledges that the Public Integrity Laws prohibit entities that meet certain criteria from bidding on or entering into or renewing a contract with governmental entities, including with the District (“**Prohibited Criteria**”).

Contractor acknowledges that the District may terminate this Agreement if the Contractor is found to have met the Prohibited Criteria or violated the Public Integrity Laws.

Contractor certifies that in entering into this Agreement, neither it nor any of its officers, directors, executives, partners, shareholders, employees, members, or agents who are active in the management of the entity, nor any affiliate of the entity, meets any of the Prohibited Criteria, and in the event such status changes, Contractor shall immediately notify the District. By entering into this Agreement, Contractor agrees that any renewal or extension of this Contract shall be deemed a recertification of such status.

SECTION 31. E-VERIFY REQUIREMENTS. The Contractor shall comply with and perform all applicable provisions of Section 448.095, *Florida Statutes*. Accordingly, beginning January 1, 2021, to the extent required by Florida Statute, Contractor shall register with and use the United States Department of Homeland Security’s E-Verify system to verify the work authorization status of all newly hired employees. The District may terminate this Agreement immediately for cause if there is a good faith belief that the Contractor has knowingly violated Section 448.091, *Florida Statutes*.

If the Contractor anticipates entering into agreements with a subcontractor for the Work, Contractor will not enter into the subcontractor agreement without first receiving an affidavit from the subcontractor regarding compliance with Section 448.095, *Florida Statutes*, and stating that the subcontractor does not employ, contract with, or subcontract with an unauthorized alien. Contractor shall maintain a copy of such affidavit for the duration of the agreement and provide a copy to the District upon request.

In the event that the District has a good faith belief that a subcontractor has knowingly violated Section 448.095, *Florida Statutes*, but the Contractor has otherwise complied with its obligations

hereunder, the District shall promptly notify the Contractor. The Contractor agrees to immediately terminate the agreement with the subcontractor upon notice from the District. Further, absent such notification from the District, the Contractor or any subcontractor who has a good faith belief that a person or entity with which it is contracting has knowingly violated s. 448.09(1), *Florida Statutes*, shall promptly terminate its agreement with such person or entity.

By entering into this Agreement, the Contractor represents that no public employer has terminated a contract with the Contractor under Section 448.095(2)(c), *Florida Statutes*, within the year immediately preceding the date of this Agreement.

SECTION 32. COMPLIANCE WITH SECTION 20.055, FLORIDA STATUTES. The Contractor agrees to comply with Section 20.055(5), *Florida Statutes*, to cooperate with the inspector general in any investigation, audit, inspection, review, or hearing pursuant such section and to incorporate in all subcontracts the obligation to comply with Section 20.055(5), *Florida Statute*.

SECTION 33. Effective Date and Term. This Agreement shall become effective as of December 1, 2025 (“Effective Date”), and remain in effect until November 30, 2026. At the end of the Initial Term, this Agreement shall automatically renew for four (4) additional one (1) year annual terms unless terminated earlier by either party in accordance with the terms provided herein.

[continued on following page]

IN WITNESS WHEREOF, the parties hereto have executed this Agreement to be effective as of the Effective Date.

Attest:

FINLEY WOODS COMMUNITY
DEVELOPMENT DISTRICT

Secretary / Assistant Secretary

Chairperson, Board of Supervisors

Witness:

GRASSHOPPERS TOTAL LAWN CARE, LLC

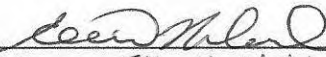

Print Name: Fernando Rodriguez

By: 

Print Name: Elliott Neblett
Title: General Manager

Composite Exhibit A: Proposals
Exhibit B: Maintenance Map

COMPOSITE EXHIBIT A

Proposals



Finley Woods 1C Common Areas
SW 46th Dr
Gainesville, FL 32608

Thank you for considering Grasshoppers Total Lawn Care to provide a proposal on your property. The following will be a breakdown of the services offered and the cost thereof.

Maintenance Schedule

Frequency of Service:

- Weekly June - August
- Bi-weekly March - May as well as September & October
- Once a month - November - February

Scope of Services

1. Turf Areas

- all turf areas will be mowed to the necessary height during the growing season to maintain a neat and healthy appearance. Appropriate height of 4" for Saint Augustine grass and 3" for Bahia grass. Areas will be cleared of the breeze and excessive clippings.
- String trimming will be used in areas where mowers cannot reach; these areas will be trimmed to same height and mow turf.
- Retention areas shall be mowed with the same frequency as common turfs areas up to the no mow areas in the middle of the retention ponds.

2. Edging

- Edging all plant beds, sidewalks, and curbs shall be edged biweekly during growing season and as needed throughout the remainder of the year.

3. Shrubby/Trees

- Shrub and ornamental pruning shall be maintained regularly throughout the year to keep them healthy. Seasonal trimming shall be done at the appropriate time based on the tree, plant and shrub.
- Tree pruning will be done to maintain 10-foot clearance over walkways and 12-foot clearance in open areas and will be done in the off-season slower months.
- Azaleas, Camellias, Gardenias, Crape myrtles, and ornamental grasses will be prune during the appropriate season to maintain health.

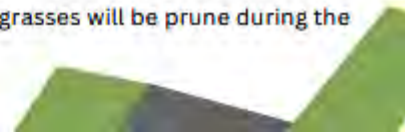



4. Weed Control in Landscape Beds

- Landscape beds will be monitored and treated as needed during each visit to keep them free from unwanted vegetation. We will utilize a combination of manual hand-pulling and targeted herbicide treatments to effectively control weeds.

5. Trash/Debris/Litter

- All trash and debris such as sticks, limbs, and pinecones will be removed before mowing.
- Storm damaged debris/clean-up will be reviewed on a per storm basis.

6. Mulch/Pine Straw and Flower Planting

- Additional Services to be quoted as needed.

Cost

The cost per month for Mowing and maintenance will be \$1500.00 per month.



Finley Woods Phase 2 Common Areas
SW 46th Dr
Gainesville, FL 32608

Thank you for considering Grasshoppers Total Lawn Care to provide a proposal on your property. The following will be a breakdown of the services offered and the cost thereof.

Maintenance Schedule

Frequency of Service:

- Weekly June - August
- Bi-weekly March - May as well as September & October
- Once a month - November - February

Scope of Services

1. Turf Areas

- all turf areas will be mowed to the necessary height during the growing season to maintain a neat and healthy appearance. Appropriate height of 4" for Saint Augustine grass and 3" for Bahia grass. Areas will be cleared of the breeze and excessive clippings.
- String trimming will be used in areas where mowers cannot reach; these areas will be trimmed to same height and mow turf.
- Retention areas shall be mowed with the same frequency as common turfs areas up to the no mow areas in the middle of the retention ponds.

2. Edging

- Edging all plant beds, sidewalks, and curbs shall be edged biweekly during growing season and as needed throughout the remainder of the year.

3. Shrubbery/Trees

- Shrub and ornamental pruning shall be maintained regularly throughout the year to keep them healthy. Seasonal trimming shall be done at the appropriate time based on the tree, plant and shrub.
- Tree pruning will be done to maintain 10-foot clearance over walkways and 12-foot clearance in open areas and will be done in the off-season slower months.
- Azaleas, Camellias, Gardenias, Crape myrtles, and ornamental grasses will be prune during the appropriate season to maintain health.

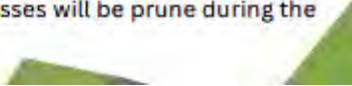



4. Weed Control in Landscape Beds

- Landscape beds will be monitored and treated as needed during each visit to keep them free from unwanted vegetation. We will utilize a combination of manual hand-pulling and targeted herbicide treatments to effectively control weeds.

5. Trash/Debris/Litter

- All trash and debris such as sticks, limbs, and pinecones will be removed before mowing.
- Storm damaged debris/clean-up will be reviewed on a per storm basis.

6. Mulch/Pine Straw and Flower Planting

- Additional Services to be quoted as needed.

Cost

The cost per month for Mowing and maintenance will be \$1600.00 per month.

Exhibit B

Maintenance Map

Finley Woods 1C Common Area Maintained by CDB

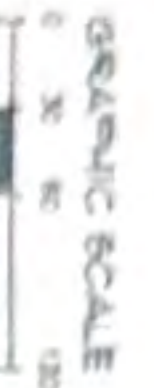

ALL LINES ON THIS PLAN SHOW THE EXACT LOCATION OF THE PROPOSED DEVELOPMENT. THE EXACT LOCATION OF THE PROPOSED DEVELOPMENT IS SHOWN BY THE GREEN HATCHED AREA. THE EXACT LOCATION OF THE PROPOSED DEVELOPMENT IS SHOWN BY THE GREEN HATCHED AREA. THE EXACT LOCATION OF THE PROPOSED DEVELOPMENT IS SHOWN BY THE GREEN HATCHED AREA.



BENCHMARK
N 1/4 COR. OF SEC. 21, T. 15N, R. 17E, S. 15
ELEVATION = 72.71 (NAVD83)

FINLEY WOODS, PHASE 1C
A PLANNED DEVELOPMENT
SITUATED IN SECTION 21, TOWNSHIP 15 SOUTH, RANGE 17 EAST, CITY
CITY OF GAINESVILLE, ALACHUA COUNTY, FLORIDA

CHIXI
Professional Engineer
No. 12345
State of Florida

PLAT BOOK 34, PAGE 19
SHEET ONE OF TWO

See Surveyors Acc'davit - Instrument # 3155484
Book 4157 Page 156 recorded 10/15/2007



REVISIONS NOTES:

1. CORRECTED THE LOCATION OF THE PROPOSED DEVELOPMENT TO BE ACCURATE TO THE SURVEY DATA.
2. CORRECTED THE LOCATION OF THE PROPOSED DEVELOPMENT TO BE ACCURATE TO THE SURVEY DATA.
3. CORRECTED THE LOCATION OF THE PROPOSED DEVELOPMENT TO BE ACCURATE TO THE SURVEY DATA.
4. CORRECTED THE LOCATION OF THE PROPOSED DEVELOPMENT TO BE ACCURATE TO THE SURVEY DATA.
5. CORRECTED THE LOCATION OF THE PROPOSED DEVELOPMENT TO BE ACCURATE TO THE SURVEY DATA.
6. CORRECTED THE LOCATION OF THE PROPOSED DEVELOPMENT TO BE ACCURATE TO THE SURVEY DATA.
7. CORRECTED THE LOCATION OF THE PROPOSED DEVELOPMENT TO BE ACCURATE TO THE SURVEY DATA.
8. CORRECTED THE LOCATION OF THE PROPOSED DEVELOPMENT TO BE ACCURATE TO THE SURVEY DATA.
9. CORRECTED THE LOCATION OF THE PROPOSED DEVELOPMENT TO BE ACCURATE TO THE SURVEY DATA.
10. CORRECTED THE LOCATION OF THE PROPOSED DEVELOPMENT TO BE ACCURATE TO THE SURVEY DATA.

DESCRIPTION:

The subject parcels are located in the SW 1/4 of Section 21, Township 15 South, Range 17 East, City of Gainesville, Alachua County, Florida. The subject parcels are located in the SW 1/4 of Section 21, Township 15 South, Range 17 East, City of Gainesville, Alachua County, Florida. The subject parcels are located in the SW 1/4 of Section 21, Township 15 South, Range 17 East, City of Gainesville, Alachua County, Florida.

CURVE DATA TABLE

CHORD BEARING	CHORD DISTANCE	DELTA	DELTA BEARING	DELTA DISTANCE
S 89° 52' 30" E	100.00	77.46	S 10° 07' 30" E	100.00
S 89° 52' 30" E	100.00	77.46	S 10° 07' 30" E	100.00
S 89° 52' 30" E	100.00	77.46	S 10° 07' 30" E	100.00
S 89° 52' 30" E	100.00	77.46	S 10° 07' 30" E	100.00
S 89° 52' 30" E	100.00	77.46	S 10° 07' 30" E	100.00
S 89° 52' 30" E	100.00	77.46	S 10° 07' 30" E	100.00
S 89° 52' 30" E	100.00	77.46	S 10° 07' 30" E	100.00
S 89° 52' 30" E	100.00	77.46	S 10° 07' 30" E	100.00
S 89° 52' 30" E	100.00	77.46	S 10° 07' 30" E	100.00
S 89° 52' 30" E	100.00	77.46	S 10° 07' 30" E	100.00

LAND DATA TABLE

LINE	DIRECTION	LENGTH
1	N 89° 52' 30" E	100.00
2	S 10° 07' 30" E	100.00
3	N 89° 52' 30" E	100.00
4	S 10° 07' 30" E	100.00
5	N 89° 52' 30" E	100.00
6	S 10° 07' 30" E	100.00
7	N 89° 52' 30" E	100.00
8	S 10° 07' 30" E	100.00
9	N 89° 52' 30" E	100.00
10	S 10° 07' 30" E	100.00
11	N 89° 52' 30" E	100.00
12	S 10° 07' 30" E	100.00
13	N 89° 52' 30" E	100.00
14	S 10° 07' 30" E	100.00
15	N 89° 52' 30" E	100.00
16	S 10° 07' 30" E	100.00
17	N 89° 52' 30" E	100.00
18	S 10° 07' 30" E	100.00
19	N 89° 52' 30" E	100.00
20	S 10° 07' 30" E	100.00
21	N 89° 52' 30" E	100.00
22	S 10° 07' 30" E	100.00
23	N 89° 52' 30" E	100.00
24	S 10° 07' 30" E	100.00
25	N 89° 52' 30" E	100.00
26	S 10° 07' 30" E	100.00
27	N 89° 52' 30" E	100.00
28	S 10° 07' 30" E	100.00
29	N 89° 52' 30" E	100.00
30	S 10° 07' 30" E	100.00
31	N 89° 52' 30" E	100.00
32	S 10° 07' 30" E	100.00
33	N 89° 52' 30" E	100.00
34	S 10° 07' 30" E	100.00
35	N 89° 52' 30" E	100.00
36	S 10° 07' 30" E	100.00
37	N 89° 52' 30" E	100.00
38	S 10° 07' 30" E	100.00
39	N 89° 52' 30" E	100.00
40	S 10° 07' 30" E	100.00
41	N 89° 52' 30" E	100.00
42	S 10° 07' 30" E	100.00
43	N 89° 52' 30" E	100.00
44	S 10° 07' 30" E	100.00
45	N 89° 52' 30" E	100.00
46	S 10° 07' 30" E	100.00
47	N 89° 52' 30" E	100.00
48	S 10° 07' 30" E	100.00
49	N 89° 52' 30" E	100.00
50	S 10° 07' 30" E	100.00
51	N 89° 52' 30" E	100.00
52	S 10° 07' 30" E	100.00
53	N 89° 52' 30" E	100.00
54	S 10° 07' 30" E	100.00
55	N 89° 52' 30" E	100.00
56	S 10° 07' 30" E	100.00
57	N 89° 52' 30" E	100.00
58	S 10° 07' 30" E	100.00
59	N 89° 52' 30" E	100.00
60	S 10° 07' 30" E	100.00
61	N 89° 52' 30" E	100.00
62	S 10° 07' 30" E	100.00
63	N 89° 52' 30" E	100.00
64	S 10° 07' 30" E	100.00
65	N 89° 52' 30" E	100.00
66	S 10° 07' 30" E	100.00
67	N 89° 52' 30" E	100.00
68	S 10° 07' 30" E	100.00
69	N 89° 52' 30" E	100.00
70	S 10° 07' 30" E	100.00
71	N 89° 52' 30" E	100.00
72	S 10° 07' 30" E	100.00
73	N 89° 52' 30" E	100.00
74	S 10° 07' 30" E	100.00
75	N 89° 52' 30" E	100.00
76	S 10° 07' 30" E	100.00
77	N 89° 52' 30" E	100.00
78	S 10° 07' 30" E	100.00
79	N 89° 52' 30" E	100.00
80	S 10° 07' 30" E	100.00
81	N 89° 52' 30" E	100.00
82	S 10° 07' 30" E	100.00
83	N 89° 52' 30" E	100.00
84	S 10° 07' 30" E	100.00
85	N 89° 52' 30" E	100.00
86	S 10° 07' 30" E	100.00
87	N 89° 52' 30" E	100.00
88	S 10° 07' 30" E	100.00
89	N 89° 52' 30" E	100.00
90	S 10° 07' 30" E	100.00
91	N 89° 52' 30" E	100.00
92	S 10° 07' 30" E	100.00
93	N 89° 52' 30" E	100.00
94	S 10° 07' 30" E	100.00
95	N 89° 52' 30" E	100.00
96	S 10° 07' 30" E	100.00
97	N 89° 52' 30" E	100.00
98	S 10° 07' 30" E	100.00
99	N 89° 52' 30" E	100.00
100	S 10° 07' 30" E	100.00

CERTIFICATE OF APPROVAL BY CITY OF GAINESVILLE

I, the undersigned, Mayor of the City of Gainesville, Florida, do hereby certify that the proposed development is in accordance with the Comprehensive Zoning Ordinance of the City of Gainesville, Florida, and that the proposed development is in accordance with the Comprehensive Zoning Ordinance of the City of Gainesville, Florida.

[Signature]
Mayor

CONTRACTOR'S APPROVAL

I, the undersigned, do hereby certify that the proposed development is in accordance with the Comprehensive Zoning Ordinance of the City of Gainesville, Florida, and that the proposed development is in accordance with the Comprehensive Zoning Ordinance of the City of Gainesville, Florida.

[Signature]
Contractor

STATE OF FLORIDA COUNTY OF ALACHUA

I, the undersigned, do hereby certify that the proposed development is in accordance with the Comprehensive Zoning Ordinance of the City of Gainesville, Florida, and that the proposed development is in accordance with the Comprehensive Zoning Ordinance of the City of Gainesville, Florida.

[Signature]
Notary Public

OWNER'S CERTIFICATION AND DECLARATION

I, the undersigned, do hereby certify that the proposed development is in accordance with the Comprehensive Zoning Ordinance of the City of Gainesville, Florida, and that the proposed development is in accordance with the Comprehensive Zoning Ordinance of the City of Gainesville, Florida.

[Signature]
Owner

VICINITY MAP

Finley Woods Phase 2 Common Areas

to be maintained
by CDD.

Irrigation Meters - Finley Ph. 2

FINLEY WOODS PHASE 2 9.20.22
SITUATED IN THE GAREY GRANT AND IN
SECTIONS 22 AND 27, TOWNSHIP 10 SOUTH, RANGE 19 EAST,
CITY OF GAINESVILLE, FLORIDA

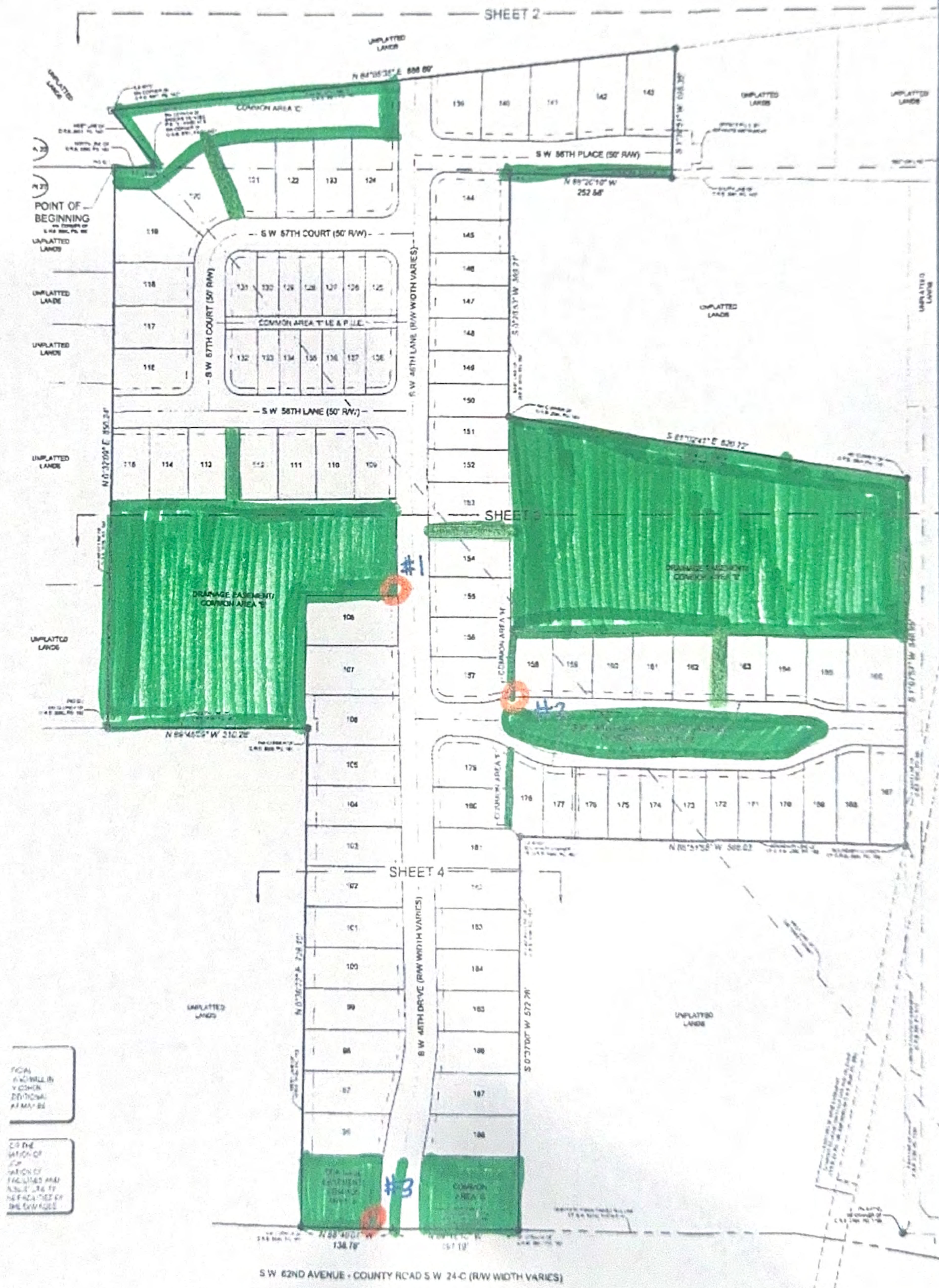

FOR A COMPLETE LIST OF COMMON AREAS AND DRAINAGE EASEMENTS, SEE THE ATTACHED COMMON AREAS AND DRAINAGE EASEMENTS MAP.

FOR A COMPLETE LIST OF COMMON AREAS AND DRAINAGE EASEMENTS, SEE THE ATTACHED COMMON AREAS AND DRAINAGE EASEMENTS MAP.

Exhibit B

Maintenance Map

Finley Woods Phase 2 Common Areas

to be maintained
by CDD.

Irrigation Meters - Finley Ph. 2

FINLEY WOODS PHASE 2 9.20.22
SITUATED IN THE GAREY GRANT AND IN
SECTIONS 22 AND 27, TOWNSHIP 10 SOUTH, RANGE 19 EAST,
CITY OF GAINESVILLE, FLORIDA

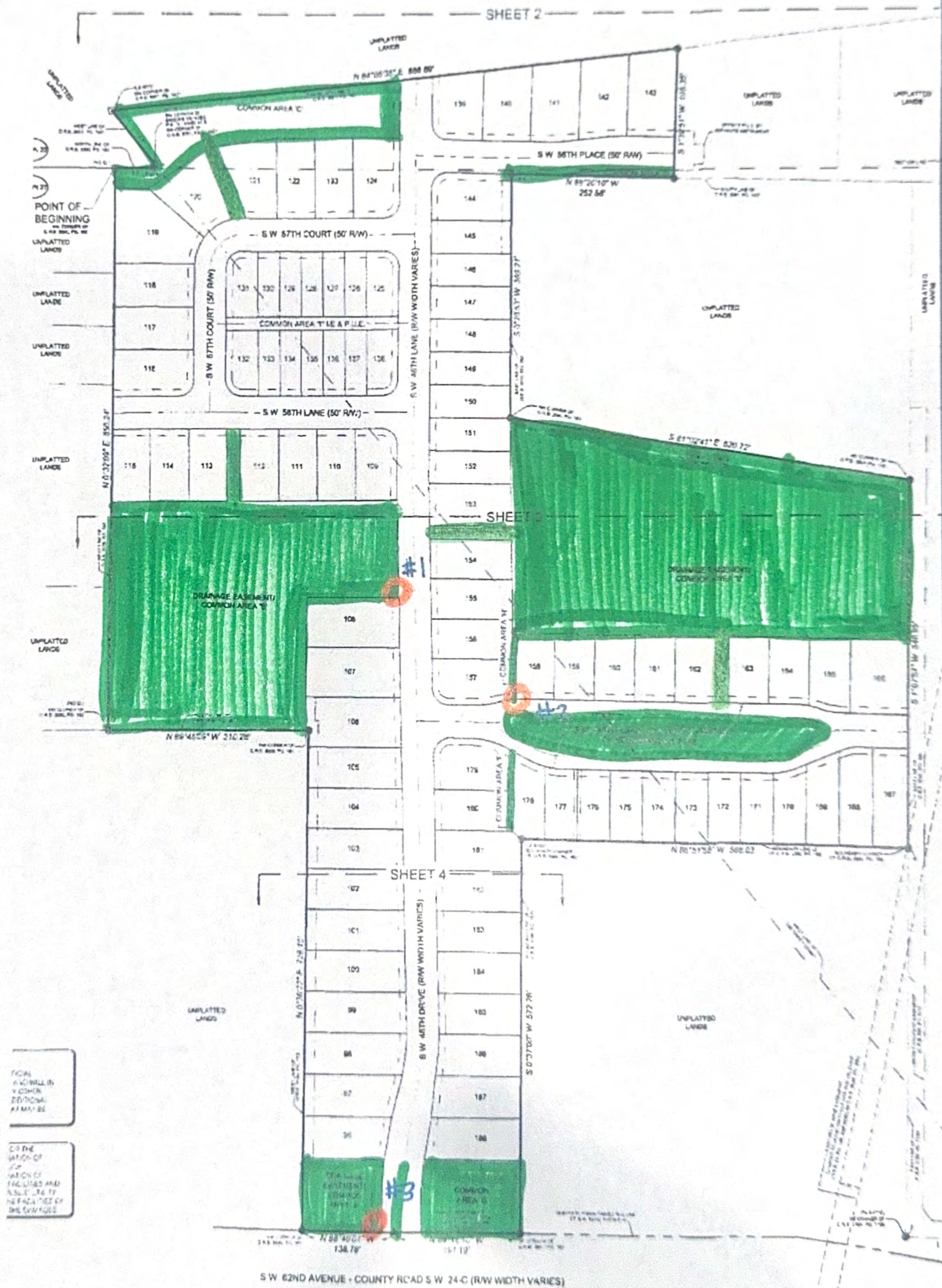

FOR
AND IN
V. OTHER
EDITIONAL
AT MAY BE

OF THE
LOCATION OF
FOR
LOCATION OF
EASEMENTS AND
RESULT OF THE
NECESSITY OF
THE EASEMENTS

S W 62ND AVENUE - COUNTY ROAD S W 24-C (RW WIDTH VARIES)



Finley Woods Community Development District

Discussion Regarding Additional Phase 1C Pond Cleanup

FIELD INSPECTION REPORT



Date: December 3, 2025	Field/GC Contact:	NV5 Project No. 19-0360	Inspected by: Jackie Curry
Morning Temperature: °F	Project: Finley Woods Phase 1C	Time/Conditions: Clear	
Afternoon Temperature: 70°F			

Inspection Type (check all that apply):

- E&S Control SMF Storm System Sanitary Sewer Potable Water
 Reclaimed Water Undercut Verification Geotextile Installation Pre-Pour Hardscape Hardscape
 Pre-Pave Asphalt Paving Asphalt Batching Other

Specify inspection:

NV5 was on site for inspection of SMF in Phase 1C.

Attachments (check all that apply):

- Progress Set Photos

Contractors and Active Equipment/Key Personnel		
1.	Site/Civil	N/A
2.	Sub/Utility	
3.	Sub/Utility	
4.	Sub/Utility	

Activities:

Weather Conflicts/Limitations:

Major and/or Controlling Work Items		No Effect All Day	Affected Less Than 50% of Workday	Affected More Than 50% of Workday	No Work All Day
1.	MES is intact. Sump is overgrown, unable to determine condition of rip rap.	<input type="checkbox"/>	<input type="checkbox"/>	<input type="checkbox"/>	<input type="checkbox"/>
2.	Fore pond is mowed and maintained. Maintenance path on west side is well maintained and defined. The south side and lower east half of the maintenance path is hard to define.	<input type="checkbox"/>	<input type="checkbox"/>	<input type="checkbox"/>	<input type="checkbox"/>
3.	The slope of the bank on the west side does not look like it has been restored to the proper grade and there is construction debris on the SMF slope.	<input type="checkbox"/>	<input type="checkbox"/>	<input type="checkbox"/>	<input type="checkbox"/>
4.	The south half of the SMF does not look to have been maintained.	<input type="checkbox"/>	<input type="checkbox"/>	<input type="checkbox"/>	<input type="checkbox"/>

N:\2019\19-0360\Construction\Field Reports\251203 Finley Woods SMF FRPT.docx

Observations:

Activity #	Description	Progress * (%)	Action Required	
			Yes	No
1.	N/A		<input type="checkbox"/>	<input type="checkbox"/>
2.			<input type="checkbox"/>	<input type="checkbox"/>
3.			<input type="checkbox"/>	<input type="checkbox"/>
4.			<input type="checkbox"/>	<input type="checkbox"/>
5.			<input type="checkbox"/>	<input type="checkbox"/>
6.			<input type="checkbox"/>	<input type="checkbox"/>
7.			<input type="checkbox"/>	<input type="checkbox"/>
<u>Recommended Actions:</u>				

*Refer to project progress set as maintained by inspector

Deficiencies:

Activity #	Description
1.	
2.	
3.	
4.	
5.	
6.	
7.	

N:\2019\19-0360\Construction\Field Reports\251203 Finley Woods SMF FRPT.docx







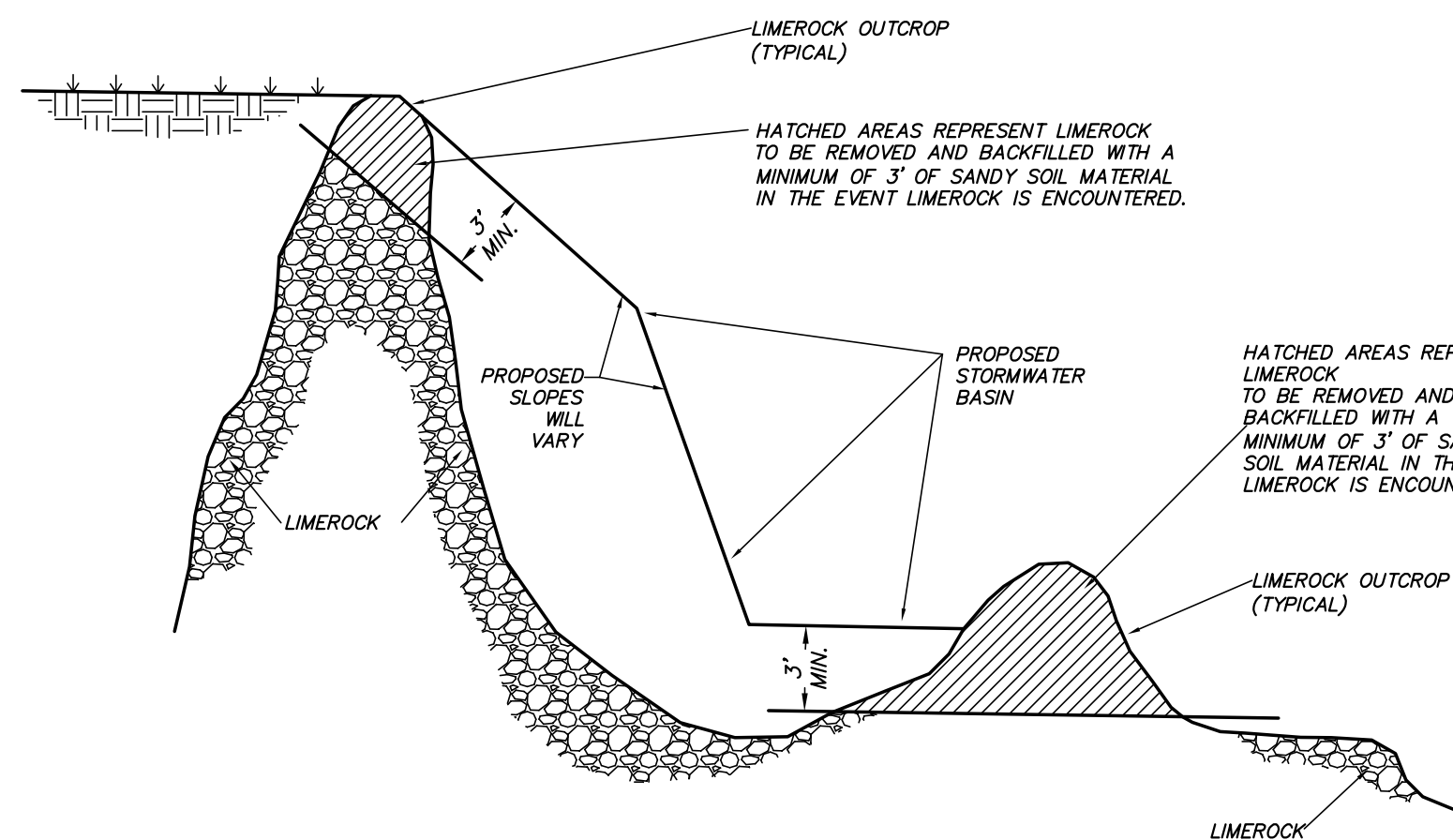

LIMEROCK OUTCROP REMOVAL DETAIL
NTS

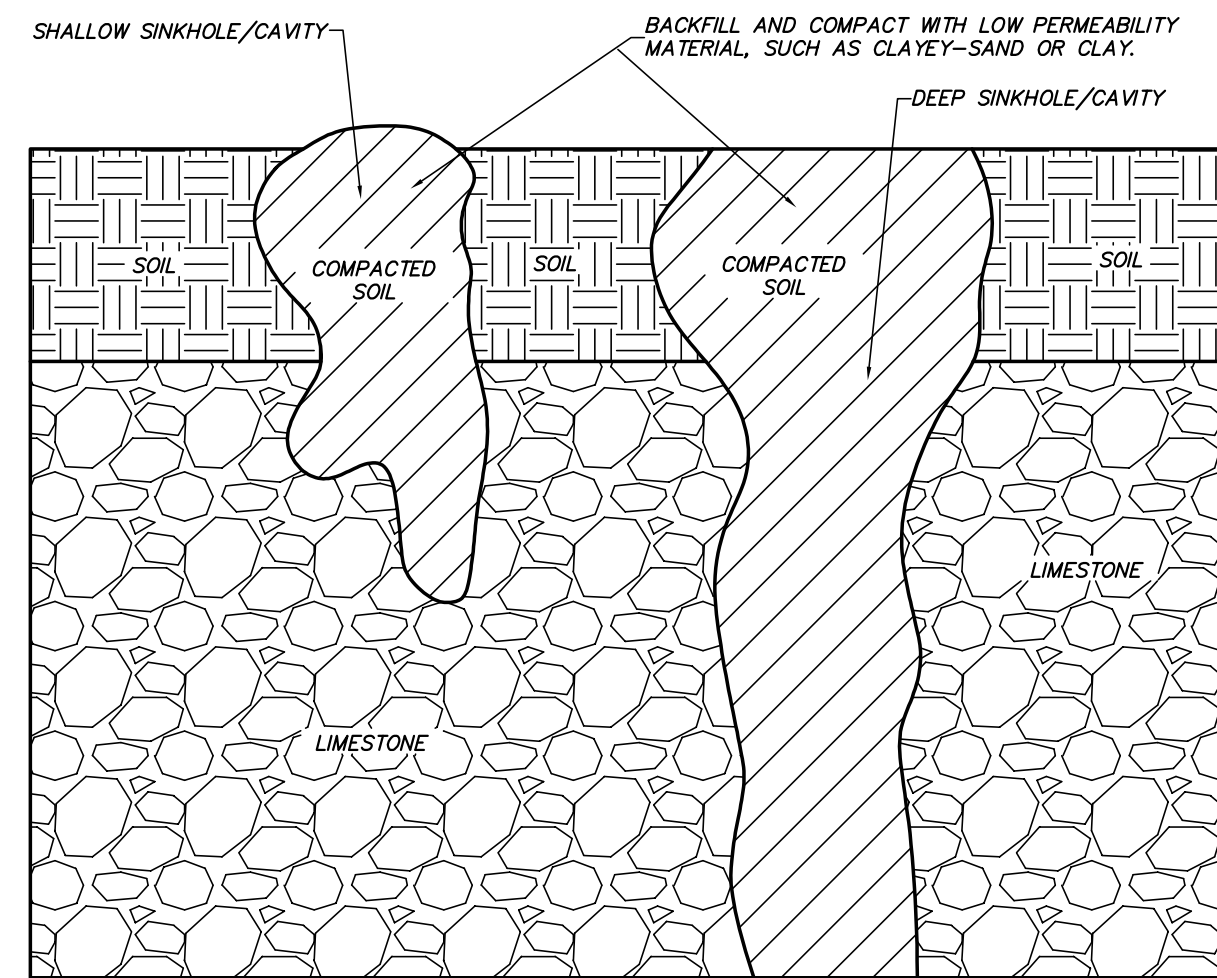

SHALLOW AND DEEP SINKHOLE/CAVITY MAINTENANCE REPAIR DETAIL
NTS

Basin Operation and Maintenance Requirements

SURFACEWATER MANAGEMENT FACILITIES (SMF'S)

ALL SMF'S PERMITTED BY THE DISTRICT SHALL BE OPERATED AND MAINTAINED IN ACCORDANCE WITH THE DESIGN'S PLANS, CALCULATIONS, AND OTHER SPECIFICATIONS THAT ARE SUBMITTED WITH AN APPLICATION, APPROVED BY THE DISTRICT AND INCORPORATED BY REFERENCE INTO ANY PERMIT ISSUED. SMF'S SHALL BE KEPT FREE OF DEBRIS, TRASH, GARBAGE, OILS AND GREASES, AND OTHER REFUSE THROUGH REGULAR INSPECTION AND MAINTENANCE BY THE PERMITTEE.

EROSION CONTROL

THE SYSTEM SHALL BE REGULARLY INSPECTED AND MAINTAINED BY THE PERMITTEE TO INSURE THAT ALL EROSION IS CONTROLLED AND SOIL IS STABILIZED TO PREVENT SEDIMENT DISCHARGE TO WATERS IN THE STATE. ANY VEGETATION ESTABLISHED FOR EROSION CONTROL SHALL BE PROPERLY MAINTAINED FOR FUNCTION.

CULVERTS, PIPES AND STRUCTURES

ALL STRUCTURES WITHIN THE SYSTEM SHALL BE REGULARLY INSPECTED AND MAINTAINED ON A REGULAR BASIS BY THE PERMITTEE TO INSURE THAT THEY DO NOT BECOME CLOGGED OR CHOKED WITH VEGETATIVE OR AQUATIC GROWTH TO SUCH AN EXTENT AS TO RENDER THEM INOPERABLE.

MAINTENANCE

THE BASIN SHALL BE REGULARLY MOWED TO AVOID EXCESSIVE VEGETATION GROWTH. THE MOWING RATE SHALL BE AT A MINIMUM OF 12 TIMES PER YEAR, WITH MORE FREQUENT MOWING IN THE SUMMER MONTHS. BASIN SIDE SLOPES SHALL INITIALLY BE SODDED AND THE SOD MAINTAINED.

FUNCTION

BASINS THAT DO NOT DRAINDOWN PROPERLY AND MAINTAIN STANDING WATER FOR AN EXTENDED PERIOD OF TIME MAY REQUIRE REMEDIAL ACTION. THE ENGINEER SHALL BE NOTIFIED TO HELP COORDINATE REMEDIAL ACTION IN THE EVENT IMPROPER RECOVERY IS NOTED.

LIMEROCK/SINKHOLE

IF A CONTINUOUS LIMEROCK FORMATION IS ENCOUNTERED DURING EXCAVATION OF THE SWALES/BASIN OR IF A SINKHOLE FORMS IN THE AREA OF A DRAINAGE SWALE/BASIN THE ENGINEER OF RECORD SHALL BE NOTIFIED BY EITHER THE CONTRACTOR OR THE ESTABLISHED OPERATION AND MAINTENANCE ENTITY. THE ENGINEER OF RECORD SHALL INSPECT THE REPAIRED AREA UPON COMPLETION OF THE REPAIR.

WHERE A CONTINUOUS LIMEROCK FORMATION IS ENCOUNTERED DURING EXCAVATION OF THE SWALES/BASINS, THE LIMEROCK SHALL BE OVER EXCAVATED BY 3 FEET AN APPROVED GEO TEXTILE FABRIC SHALL BE PLACED IN THE EXCAVATION AND BACKFILLED WITH SANDY SOILS IN A LOOSE CONDITION.

ALL SWALES/BASINS SHALL BE INSPECTED MONTHLY FOR SINKHOLE OCCURRENCE. SHOULD A SINKHOLE OCCUR, THE AREA SHALL BE REPAIRED AS SOON AS POSSIBLE. REPAIR SHALL INCLUDE FILLING (LIMEROCK SUCH AS ROAD BASE MATERIAL, CLAY/SAND MIXTURE, OR CONCRETE IF NECESSARY). A 3-FOOT DEEP CAP THAT EXTENDS 3 FEET BEYOND THE PERIMETER OF THE SINKHOLE SHALL BE CONSTRUCTED WITH CLAYEY SOILS. THE CLAYEY SOIL SHALL HAVE AT LEAST 20% PASSING THE NO. 200 SIEVE, COMPACTED TO 95% OF STANDARD PROCTOR, AND COMPACTED IN A WET CONDITION WITH MOISTURE 2% - 4% ABOVE OPTIMUM. THE CLAY SOIL CAP SHALL BE RE-GRADED TO PREVENT CONCENTRATION OF WATERS (PONDING) AND RE-VEGETATED.

OPERATION & MAINTENANCE ENTITY
FINLEY WOODS DEVELOPMENT, LLC

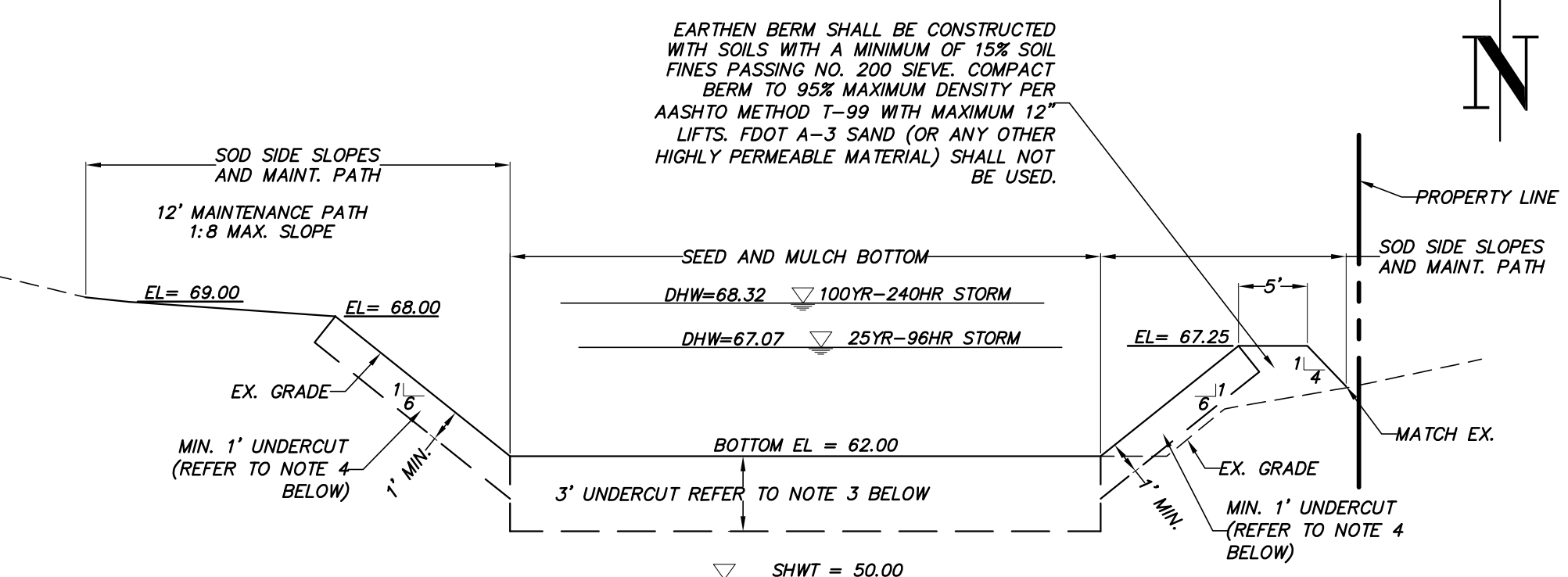
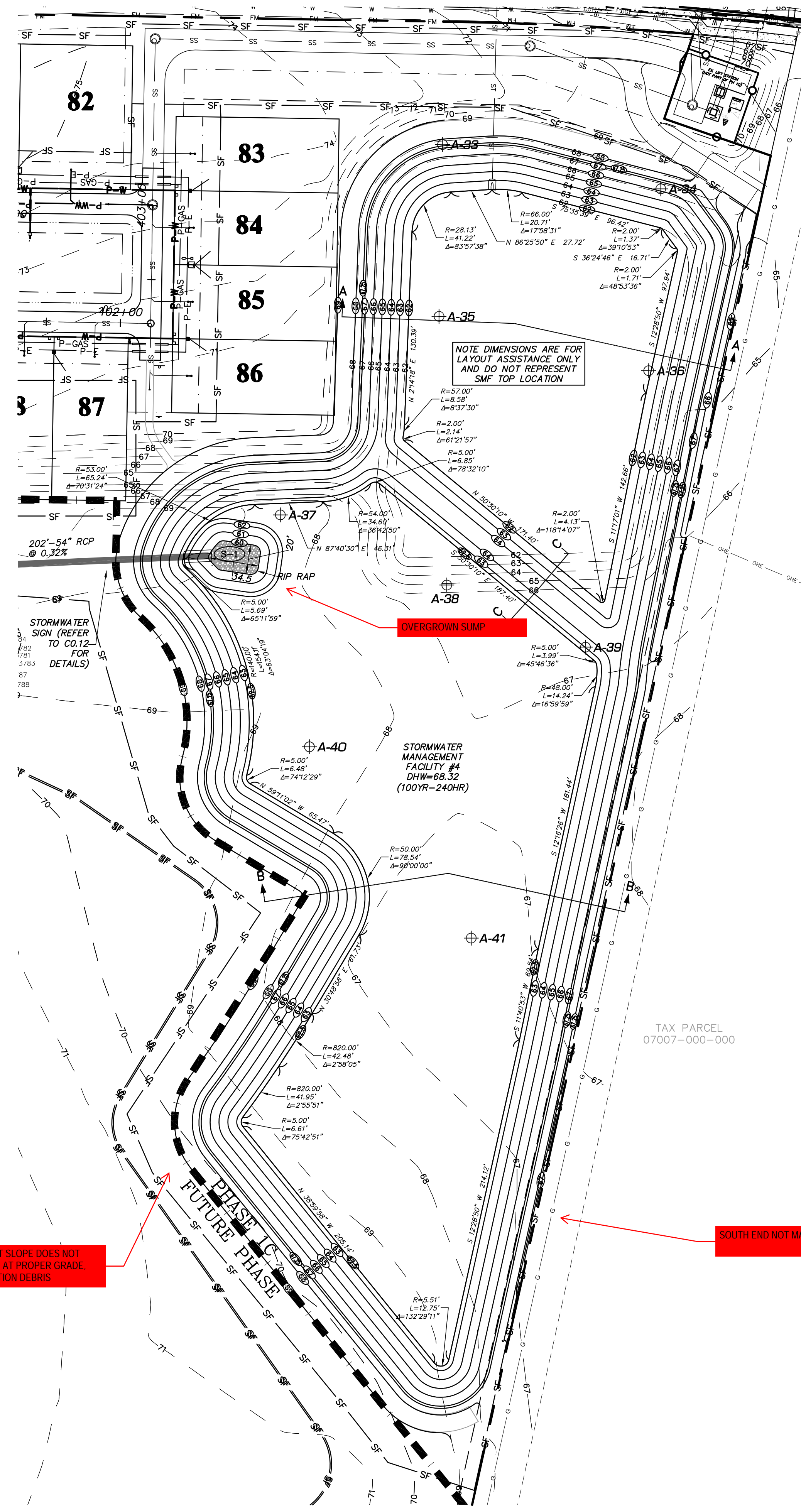

- IF A CONTINUOUS LIMEROCK FORMATION IS ENCOUNTERED IN THE BASIN AREA CONTACT THE ENGINEER OF RECORD. THE LIMEROCK SHALL BE EXCAVATED TO A MINIMUM DEPTH OF 3 FEET BEYOND THE BASIN UNDERCUT LIMITS.
- IF A SOLUTION PIPE SINKHOLE DOES FORM IN THE STORMWATER BASIN, THEN THE SINKHOLE SHALL BE REPAIRED BY BACKFILLING WITH MATERIAL OF LOWER PERMEABILITY MATERIAL, SUCH AS CLAYEY SAND OR CLAY. THE MATERIAL SHALL BE COMPACTED AND THE SINKHOLE REPAIR SHOULD BRING THE SURFACE BACK TO AN ELEVATION WHICH IS SLIGHTLY ABOVE THE ORIGINAL BOTTOM, CREATING A SMALL MOUND.
- MIN. 3" UNDERCUT (AS SHOWN ABOVE) AND BACKFILL WITH CLEAN SAND (LESS THAN 10% SOIL PASSING THE NO. 200 SIEVE, WITH ±24" LIFTS LOOSELY COMPACTED TO 90% MODIFIED STANDARD PROCTOR DRY DENSITY). BACKFILL SAND MUST BE TESTED TO HAVE PERMEABILITY RATES BETWEEN THE FOLLOWING PARAMETERS:
MIN K_v=10 FT/DAY
MAX K_v=20 FT/DAY
MIN K_h=15 FT/DAY
MAX K_h=30 FT/DAY
- MIN. 1" UNDERCUT (AS SHOWN ABOVE) AND BACKFILL WITH CLEAN SAND (LESS THAN 10% SOIL PASSING THE NO. 200 SIEVE, WITH ±24" LIFTS LOOSELY COMPACTED TO 90% MODIFIED STANDARD PROCTOR DRY DENSITY). BACKFILL SAND MUST BE TESTED TO HAVE PERMEABILITY RATES BETWEEN THE FOLLOWING PARAMETERS:
MIN K_v=10 FT/DAY
MAX K_v=20 FT/DAY
MIN K_h=15 FT/DAY
MAX K_h=30 FT/DAY

DRY STORMWATER MANAGEMENT FACILITY #4 CROSS SECTION A-A
NTS

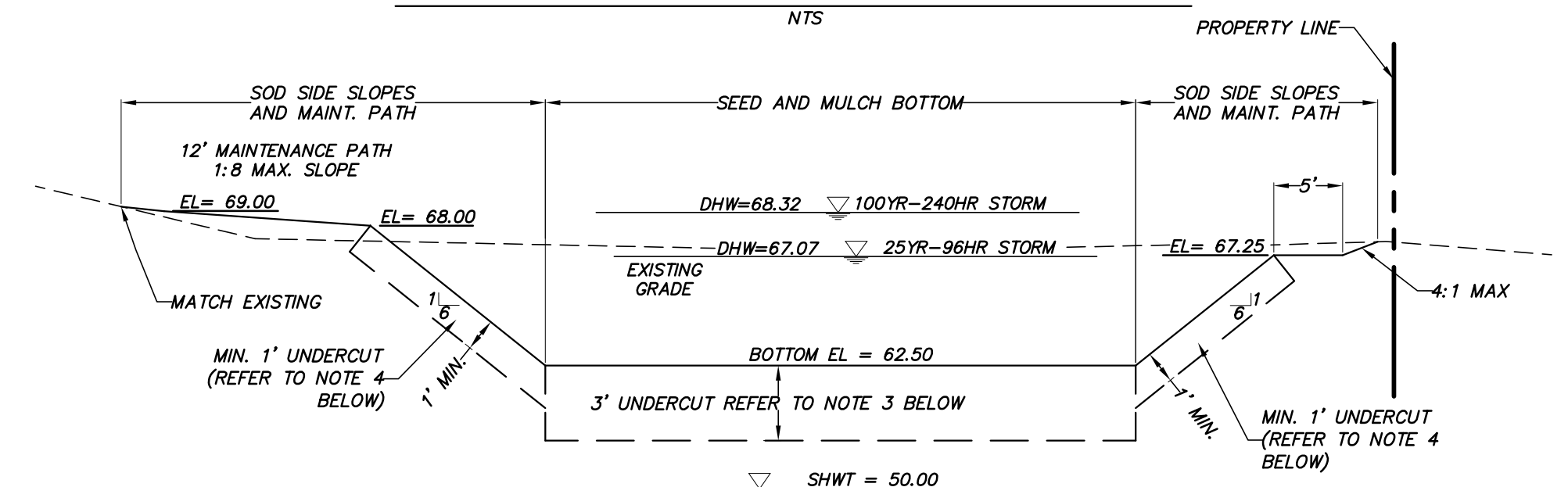

- IF A CONTINUOUS LIMEROCK FORMATION IS ENCOUNTERED IN THE BASIN AREA CONTACT THE ENGINEER OF RECORD. THE LIMEROCK SHALL BE EXCAVATED TO A MINIMUM DEPTH OF 3 FEET BEYOND THE BASIN UNDERCUT LIMITS.
- IF A SOLUTION PIPE SINKHOLE DOES FORM IN THE STORMWATER BASIN, THEN THE SINKHOLE SHALL BE REPAIRED BY BACKFILLING WITH MATERIAL OF LOWER PERMEABILITY MATERIAL, SUCH AS CLAYEY SAND OR CLAY. THE MATERIAL SHALL BE COMPACTED AND THE SINKHOLE REPAIR SHOULD BRING THE SURFACE BACK TO AN ELEVATION WHICH IS SLIGHTLY ABOVE THE ORIGINAL BOTTOM, CREATING A SMALL MOUND.
- MIN. 3" UNDERCUT (AS SHOWN ABOVE) AND BACKFILL WITH CLEAN SAND (LESS THAN 10% SOIL PASSING THE NO. 200 SIEVE, WITH ±24" LIFTS LOOSELY COMPACTED TO 90% MODIFIED STANDARD PROCTOR DRY DENSITY). BACKFILL SAND MUST BE TESTED TO HAVE PERMEABILITY RATES BETWEEN THE FOLLOWING PARAMETERS:
MIN K_v=10 FT/DAY
MAX K_v=20 FT/DAY
MIN K_h=15 FT/DAY
MAX K_h=30 FT/DAY
- MIN. 1" UNDERCUT (AS SHOWN ABOVE) AND BACKFILL WITH CLEAN SAND (LESS THAN 10% SOIL PASSING THE NO. 200 SIEVE, WITH ±24" LIFTS LOOSELY COMPACTED TO 90% MODIFIED STANDARD PROCTOR DRY DENSITY). BACKFILL SAND MUST BE TESTED TO HAVE PERMEABILITY RATES BETWEEN THE FOLLOWING PARAMETERS:
MIN K_v=10 FT/DAY
MAX K_v=20 FT/DAY
MIN K_h=15 FT/DAY
MAX K_h=30 FT/DAY

DRY STORMWATER MANAGEMENT FACILITY #4 CROSS SECTION B-B
NTS

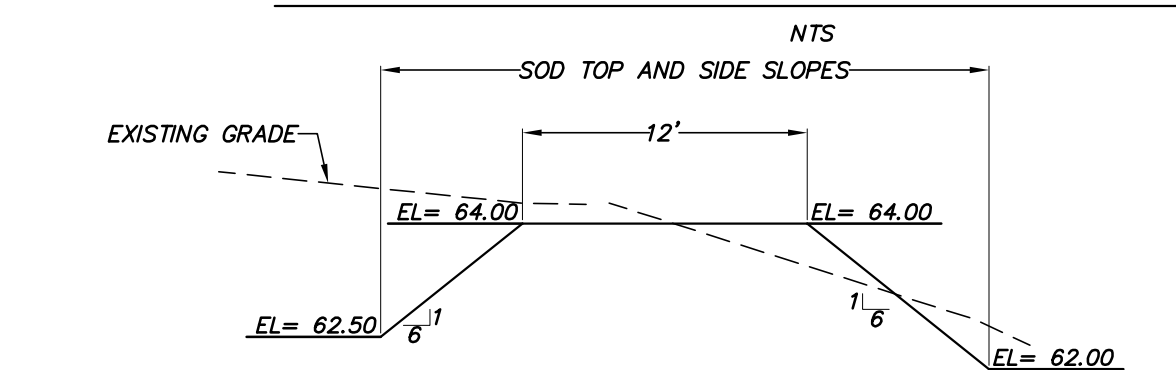

- EARTHEN BERM SHALL BE CONSTRUCTED WITH SOILS WITH A MINIMUM OF 15% SOIL FINES PASSING NO. 200 SIEVE. COMPACT BERM TO 95% MAXIMUM DENSITY PER AASHTO METHOD T-99 WITH MAXIMUM 12" LIFTS. FDOT A-3 SAND (OR ANY OTHER HIGHLY PERMEABLE MATERIAL) SHALL NOT BE USED.

DRY STORMWATER MANAGEMENT FACILITY #4 - BERM CROSS SECTION C-C
NTS

132 NW 76th Drive
Gainesville, Florida 32607
(852) 351-1976 / (850) 351-2476
www.dhw-inc.com

FLORIDA
Professional Consultants
Professional Seal
SCALE: 1"=50'
BASED ON THE ORIGINAL DRAWING
THIS SHEET SHALL BE ADJUSTED TO THE ORIGINAL DRAWING
SCALE AS INDICATED

REGISTRAR:
01/19/16 ALACHUA COUNTY, GRU & CLAY ELECTRIC
02/07/16 ALACHUA COUNTY, GRU & CLAY ELECTRIC
03/28/16 ALACHUA COUNTY
04/13/16 BOCC
05/11/16 APCWD FOR CONSTRUCTION PERMIT
06/16/16 100% DOCUMENT

CLIENT:
FINLEY WOODS DEVELOPMENT, LLC

PROJECT:
FINLEY WOODS PHASE 1C

DESIGNER:
D.H. YOUNG, P.E.

QUALITY CONTROL:
M. HEATHCOCK, P.E.

SHEET NUMBER:
14-0348

DESIGNED BY:
WALTER JARVIS

FL PE No. 69101
SHEET NO.
C2.30



Finley Woods Community Development District

Request for Repair Work



01/05/2026 14:21



OBJECTS IN MIRROR ARE
CLOSER THAN THEY APPEAR

01/05/2026 14:20



01/05/2026 14:20



Finley Woods Community Development District

**Ratification of Additional Phase 1C Pond
Cleanup Proposal with Grasshopper TLC**

STRUCTURE:	STRUCTURE TYPE	TOP	INVERT ELEV	PIPE DIA.	NORTHING & EASTING
S-1	36" MITERED END SECTION PER FDOT INDEX 430-021	N/A	59.00' W	36"	N: 19926.46 E: 37455.93
S-2	STORM MANHOLE PER FDOT INDEX 425-001	66.90'	60.00' S 59.40' E 59.40' N 59.40' W	24" 36" 36" 36"	N: 19928.35 E: 37249.37
S-3	36" MITERED END SECTION PER FDOT INDEX 430-021	N/A	59.00' E	36"	N: 19920.53 E: 37148.58
S-4	TYPE 3 CURB INLET PER FDOT INDEX 425-020	67.50'	60.25' S 60.25' N 60.25' W	24" 24" 18"	N: 19858.09 E: 37250.13
S-5	TYPE 3 CURB INLET PER FDOT INDEX 425-020	67.50'	62.50' E	18"	N: 19857.54 E: 37217.14
S-6	STORM MANHOLE PER FDOT INDEX 425-001	68.11'	61.15' S 61.15' N	24" 24"	N: 19604.82 E: 37254.35
S-8	TYPE 4 CURB INLET PER FDOT INDEX 425-020	67.43'	62.17' W 62.17' S 62.09' N	18" 18" 24"	N: 19363.19 E: 37258.37
S-9	TYPE 4 CURB INLET PER FDOT INDEX 425-020	67.43'	62.34' E	18"	N: 19363.77 E: 37225.36
S-10	TYPE 3 CURB INLET PER FDOT INDEX 425-020	70.14'	65.18' W 65.18' N	18" 18"	N: 19123.32 E: 37255.40
S-11	TYPE 3 CURB INLET PER FDOT INDEX 425-020	70.52'	65.25' E	18"	N: 19123.83 E: 37220.72
S-12	TYPE 4 CURB INLET PER FDOT INDEX 425-020	66.76'	59.55' S 60.15' W 59.55' N	36" 18" 30"	N: 20004.27 E: 37247.84
S-13	TYPE 4 CURB INLET PER FDOT INDEX 425-020	66.76'	61.76' E	18"	N: 20004.30 E: 37214.85
S-14	TYPE 3 CURB INLET PER FDOT INDEX 425-020	67.76'	59.88' S 60.75' W 59.88' N	30" 18" 24"	N: 20204.34 E: 37249.94
S-15	TYPE 3 CURB INLET PER FDOT INDEX 425-020	67.76'	61.76' E	18"	N: 20204.69 E: 37216.94
S-16	STORM MANHOLE PER FDOT INDEX 425-001	67.78'	62.16' N 62.16' S 62.16' E	18" 24" 24"	N: 20485.19 E: 37252.95
S-17	TYPE 4 CURB INLET PER FDOT INDEX 425-020	67.40'	62.39' S 62.39' N	18" 18"	N: 20575.77 E: 37253.90
S-18	TYPE 4 CURB INLET PER FDOT INDEX 425-020	67.40'	62.46' E	18"	N: 20576.12 E: 37220.90
S-19	TYPE 4 CURB INLET PER FDOT INDEX 425-020	67.56'	62.34' N 62.34' W 62.34' E	18" 24" 24"	N: 20483.30 E: 37308.88
S-20	TYPE 4 CURB INLET PER FDOT INDEX 425-020	67.56'	62.44' S	18"	N: 20516.29 E: 37309.84
S-21	TYPE 3 CURB INLET PER FDOT INDEX 425-020	69.33'	62.90' W 63.50' N 62.90' E	24" 18" 24"	N: 20487.85 E: 37564.95
S-22	TYPE 3 CURB INLET PER FDOT INDEX 425-020	69.33'	64.00' S	18"	N: 20520.84 E: 37565.50

NOTE: CHAIN GRATES IN ACCORDANCE WITH FDOT INDEX 425-001

GENERAL NOTES:

- ALL WORK WITHIN OR ON CITY OWNED OR MAINTAINED FACILITIES, ROW OR EASEMENT WILL REQUIRE AS-BUILT PLANS. AS-BUILT PLANS SHOULD SHOW THE CONSTRUCTED CONDITIONS OF THE CITY OWNED OR MAINTAINED AREA AND BE PERFORMED BY A FLORIDA LICENSED PROFESSIONAL SURVEYOR AND MAPPER. REQUIREMENTS FURTHER DESCRIBED IN THE CITY OF GAINESVILLE DESIGN AND CONSTRUCTION MANUAL (CURRENT EDITION) SECTION 8.3.
- THE CONTRACTOR SHALL PROVIDE THE CITY WITH AN AS-BUILT SURVEY OF THE RETENTION/DETENTION BASIN AND ASSOCIATED STRUCTURES, PREPARED BY A REGISTERED LAND SURVEYOR. THE SURVEY SHALL BE SUBMITTED ON PAPER COPY AND ELECTRONICALLY (PDF AUTODESK CAD) REQUIREMENTS FURTHER DESCRIBED IN THE CITY OF GAINESVILLE DESIGN AND CONSTRUCTION MANUAL (CURRENT EDITION) SECTION 10.8.7.
- ANY CONSTRUCTION IN THE CITY OF GAINESVILLE PUBLIC ROW WILL REQUIRE PERMITS FROM THE PUBLIC WORKS DEPARTMENT PRIOR TO BEGINNING WORK. A MOT PERMIT IS REQUIRED FOR ANY ACTIVITY IN THE ROW, EITHER DIRECTLY OR INDIRECTLY AFFECTS VEHICULAR OR PEDESTRIAN TRAFFIC.
- OPEN CUT RESTORATION SHALL BE PERFORMED IN ACCORDANCE WITH FDOT INDEX 307, AND USING THE FLOWABLE FILL OPTION.
- ALL REQUIRED BACKFILL WITHIN THE ROW SHALL BE DOCUMENTED WITHIN AND FDOT TYPE DENSITY LOG BOOK, COMPILED AND MAINTAINED BY THE CONTRACTOR, AND AVAILABLE FOR REVIEW BY THE PUBLIC WORKS INSPECTOR UPON REQUEST. THIS LOG BOOK SHALL BE SIGNED AND SEALED BY THE ENGINEER AND TURNED OVER TO THE PW DEPARTMENT FOR REVIEW AND ACCEPTANCE AS PART OF THE CLOSEOUT DOCUMENTS.

NOTE:

- SEE SHEET C2.20 FOR TYPICAL LOT GRADING SCHEME.
- ALL DISTURBED AREAS SHALL BE SEEDED/SODDED.

STRUCTURE:	STRUCTURE TYPE	TOP	INVERT ELEV	PIPE DIA.	NORTHING & EASTING
S-23	30" MITERED END SECTION PER FDOT INDEX 430-021	N/A	60.00' N	30"	N: 19914.98 E: 36952.78
S-25	TYPE 3 CURB INLET PER FDOT INDEX 425-020	67.65'	61.42' N 61.42' E 61.42' S	24" 18" 30"	N: 20095.48 E: 36951.75
S-26	TYPE 4 CURB INLET PER FDOT INDEX 425-020	66.77'	61.80' N 61.80' W	18" 18"	N: 20096.49 E: 37145.79
S-27	TYPE 4 CURB INLET PER FDOT INDEX 425-020	66.77'	61.87' S	18"	N: 20129.48 E: 37145.62
S-29	STORM MANHOLE PER FDOT INDEX 425-001	67.49'	61.54' S 61.54' N	24" 24"	N: 20148.09 E: 36930.76
S-30	STORM MANHOLE PER FDOT INDEX 425-001	66.79'	61.93' E 61.93' S	24" 18"	N: 20265.45 E: 36935.03
S-31	TYPE 4 CURB INLET PER FDOT INDEX 425-020	66.99'	62.00' W 62.00' N	24" 18"	N: 20265.58 E: 36971.26
S-32	TYPE 4 CURB INLET PER FDOT INDEX 425-020	66.99'	62.07' S	18"	N: 20398.31 E: 36963.54
S-33	TYPE C INLET PER FDOT INDEX 425-052	66.70'	63.03' S	18"	N: 20521.19 E: 36913.82
S-34	24" MITERED END SECTION PER FDOT INDEX 430-021	N/A	60.00' S	24"	N: 19834.50 E: 37709.93
S-35	TYPE 4 CURB INLET PER FDOT INDEX 425-020	66.33'	61.00' S 61.00' N	18" 24"	N: 19663.10 E: 37706.54
S-36	TYPE 4 CURB INLET PER FDOT INDEX 425-020	66.18'	61.50' N	18"	N: 19577.36 E: 37684.84
S-37	TYPE 3 CURB INLET PER FDOT INDEX 425-020	67.30'	61.47' S 61.47' E	24" 18"	N: 19667.45 E: 37486.59
S-38	TYPE 3 CURB INLET PER FDOT INDEX 425-020	67.18'	62.50' N 62.50' S	18" 18"	N: 19581.32 E: 37484.88
S-39	TYPE C INLET PER FDOT INDEX 425-052	68.75'	63.10' W	24"	N: 20484.75 E: 37667.32
S-40	TYPE C INLET PER FDOT INDEX 425-052	66.00'	63.00' N	18"	N: 19469.55 E: 37482.67
S-41	TYPE C INLET PER FDOT INDEX 425-052 AND 425-010	66.00'	61.00' SE	15"	N: 20094.21 E: 37416.55
S-42	15" MITERED END SECTION PER FDOT INDEX 430-021	61.30'	60.00' NW	15"	N: 20046.95 E: 37439.87

NOTE: CHAIN GRATES IN ACCORDANCE WITH FDOT INDEX 425-001

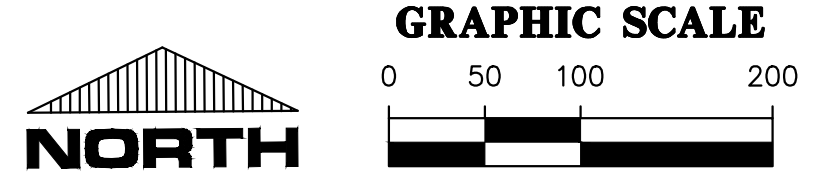
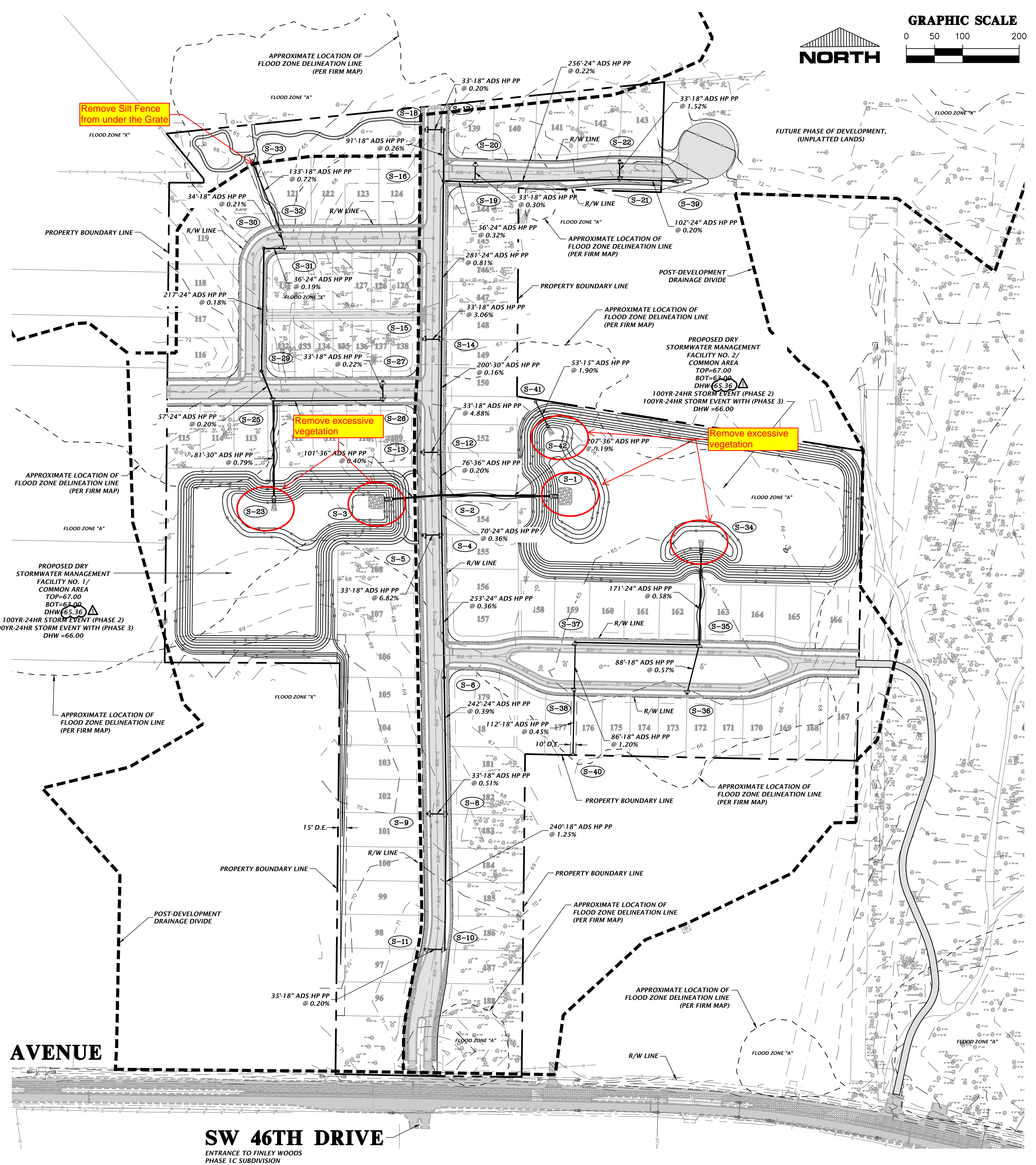

11801 Research Dr.
Alachua, Florida 32615
(352) 351-1976
www.ch2m.com
est. 1988 FLORIDA
CA-5075

CH2M
Professional Consultants

SCALE: 1"=100'
BASE SCALE ON ORIGINAL DRAWING
0" MEANS THE USER MUST ADJUST SCALES ACCORDINGLY.

CONSTRUCTION PERMITS
05/04/20 - FIELD ORDER #

DATE: 03/05/19 - COG, GRU, AND SIRWAD
05/22/19 - COG, GRU, AND SIRWAD
08/09/19 - COG AND GRU
9/25/19 - COG AND GRU

CLIENT: WMB REAL ESTATE INVESTMENT, LLC
PROJECT: FINLEY WOODS PHASE 2
SHEET TITLE: MASTER GRADING AND DRAINAGE PLAN

DESIGNER: J. THOMAS
CHECKER: J. THOMAS
QUALITY CONTROL: D. YOUNG
PROJECT NUMBER: 17-0050

DANIEL H. YOUNG

FL PE No. 70780
SHEET NO.: C2.00

Title: mch2m.dwg Plot Date: May 04, 2020 8:10am Filename: L:\2017\17-0050\Engineering\DWG\Production\17-0050_C2.00_MBP.dwg

Grasshoppers TLC
 661 SW 161st Ter
 Newberry, FL 32669 USA
 +13522194080
 grasshopperstlc@gmail.com



Estimate

ADDRESS

Finley Woods Phase 1C
 4809 SW 62nd Ave.
 Gainesville, Fl. 32608

ESTIMATE # 3759
DATE 01/07/2026

ACTIVITY	QTY	RATE	AMOUNT
<p>This estimate is for clean up at both Finley Woods Phase 1c & Finley Woods Phase 2</p> <p>Landscaping Cleanup Retention Pond Cleanup & Maintenance Prep</p> <p>This service includes a full cleanup of two overgrown retention pond areas to restore them to a safe, clean, and maintainable condition. Work will consist of mowing all accessible areas down to a manageable height to allow for consistent maintenance going forward. Any sections that are not safely accessible by mower—including slopes, edges, and tight or obstructed areas—will be trimmed using weedeaters to ensure a uniform and well-kept appearance. In addition, all visible trash and debris found within the retention pond areas will be collected and removed as part of the cleanup. All work will be performed with care to preserve the integrity of the pond areas while improving overall appearance, access, and long-term maintainability.</p>	1	3,200.00	3,200.00
<p>Disposal Disposal of all debris from job site.</p>	1	65.00	65.00
TOTAL			\$3,265.00

Accepted By

Accepted Date **01/15/2026**













Finley Woods Community Development District

Phase 3 O&M Certification of Financial Capability

Certification Of Financial Capability For Perpetual Operations And Maintenance Entities

Permit No.: _____ Application No.: **180783-2** Date Issued (if modification): _____

Identification or Name of Stormwater Management System: **SMF-3 and SMF-4**

Phase of Stormwater Management System (if applicable): **N/A**

Name of Operation and Maintenance Entity: **Finley Woods Community Development District**

Address of Operation and Maintenance Entity: **3501 Quadrangle Boulevard, Suite 270
Orlando, FL 32817**

Cost estimate attached

Total annual operating expenses, including maintenance costs, for the estimated remaining useful life of the system accounting for annualized capital or replacement costs or deferred maintenance expenses for the system, including those components where maintenance or replacement frequencies are less frequent than once per year, for each BMP in the stormwater management system and any associated infrastructure, in current year dollars.

\$38,411.85

Operation and Maintenance Entity (Select All That Apply):

- Local, state, or federal government agencies; municipal service other special taxing units, water control or drainage districts; community development, special assessment, or water management districts
- Communication, water, sewer, stormwater, electrical, or other public utility
- Construction permittee (see Section 12, Volume I)
- Non-profit corporations, including homeowners' associations, property owners' associations, condominium owners' or master associations
- Other (Describe the Other Operation and Maintenance Entity below)

Certification by Operation and Maintenance Entity:

Certification Provisions for the Operation and Maintenance Entity (Select All That Apply):

- Municipal Separate Storm Sewer System (MS4) permittee subject to Chapter 62-624, F.A.C. (Identify the applicable Florida Department of Environmental MS4 permit below:)

- Non-profit corporation subject to the Homeowners' Association Act under Chapter 720, Florida Statutes

Certification Of Financial Capability For Perpetual Operations And Maintenance Entities

Construction permittee that will not be the Operation and Maintenance Entity. (Identify the intended Operation and Maintenance Entity below:)

Other: Operation and Maintenance Entity not otherwise selected for this section. Describe the Other Operation and Maintenance Entity below, such as State or federal agency, Property Owners' Association, etc.:
Finley Woods Community Development District

The below Permittee or Operation and Maintenance Entity certifies that this form is true, accurate, and complete; and that it has the financial capability to operate and maintain the system in perpetuity including costs of inspections, operation, repair, and replacement of the system once the system meets its expected life. The signee below will be responsible for all maintenance, operation, and repair costs for the stormwater system of the above permit in perpetuity, until such time the system is properly abandoned, or the permit is transferred to a new operation and maintenance entity.

Name of Permittee or Operation and Maintenance Entity:
Development District

Finley Woods Community

Name: **Virginia Patterson**

Title: **Chair, Board of Supervisors**

Signature: _____



Date **1/28/26**



Project Name: Finley Woods Phase 3 - Lot Layout Modification
 NV5 Project No: 20-0434
 Date: 12/14/2025

Operation and Maintenance - Cost Estimate

STORMWATER FACILITY COMPONENTS	QUANTITY	UNIT
Number of Stormwater Basins	2.00	Ea.
Dry Retention Basin - (Top of Bank)	2.87	Ac.
Dry Retention Basin - (Bottom of Pond)	1.77	Ac.
Manholes/Inlets/Mitered End Sections	64.00	Ea.
Storm Pipe	4,515.00	LF.
Swales	83.00	LF.
Control Structures	0.00	Ea.
Landscaped Area	2.91	Ac.

PROJECTED SERVICE	FREQUENCY (YEARS)	COST	UNIT
Lawn Care/Landscape Maintenance	0.17	100.00	\$/Ac
Structure/Inlet Cleaning	5	65.00	\$/Ea
Minor Sinkhole Repair/Emergency Repairs	20	12,500.00	\$/Ea
Basin Sediment Removal 2" (excavator & truck)	25	15.50	\$/CY
Basin Repair (sod replacement)	25	3.60	\$/SY
Structure Repair/Replace	25	350.00	\$/Ea
Pipe Repair/Replace	50	200.00	\$/LF
Pipe Cleaning	5	10.00	\$/LF
Professional Inspection and Reporting	3	2,500.00	\$/Ea
Assumed Labor Cost		55.00	\$/Hour/Person

MAINTENANCE ACTIVITY	ANNUAL FREQUENCY	QUANTITY	UNIT	UNIT COST	ANNUAL COST
Lawn Care/Landscape Maintenance	6.00	2.91	Ac	\$ 100.00	\$ 1,744.14
Structure /Inlet Cleaning	0.20	64.00	Ea	\$ 65.00	\$ 832.00
Emergency Sinkhole Repair	0.05	2.00	Ea	\$ 12,500.00	\$ 1,250.00
Basin Sediment Removal	0.04	475.38	CY	\$ 15.50	\$ 294.73
Basin Sod Replacement	0.04	5,344.81	SY	\$ 3.60	\$ 769.65
Structure Repair/Replace	0.04	64.00	Ea	\$ 350.00	\$ 896.00
Pipe Repair/Replace	0.02	4,515.00	LF	\$ 200.00	\$ 18,060.00
Pipe Cleaning	0.20	4,515.00	LF	\$ 10.00	\$ 9,030.00
Registered Professional Inspection	0.33	1.00	Ea	\$ 2,500.00	\$ 833.33
Monthly Inspections by Maintenance Entity	12.00	1.00	Hrs	\$ 55.00	\$ 660.00
Annual Reporting by Owner	1.00	10.00	Hrs	\$ 55.00	\$ 550.00
Subtotal					\$ 34,919.86
Mobilization (10%)					\$ 3,491.99
TOTAL ANNUAL COST ESTIMATE					\$ 38,411.85

The Engineer's probable estimate of cost provided in this document is specifically intended to represent a rough order of magnitude, including all component information for line items aspects of the work, estimated quantities, and applied unit rates. The Engineer's probable estimate of cost is not intended for publication for the use of bidders whatsoever, unless represented as an FDOT Pay Item table on the plans for projects administered accordance with FDOT Standards. For bidding scenarios, the prospective bidders should be advised that they are solely responsible for: identifying and including relevant project scope, calculation of quantities/durations for takeoffs, and determining the appropriate competitive market cost for the work. Additionally, NV5 has no control over the cost of labor, materials, equipment, market conditions, or the Contractor's method of determining prices. Therefore, our statements of probable cost provided herein are made on the basis of best judgment as professional consultants familiar with the construction industry. NV5, nor its subconsultants, can offer guarantee that proposals, bids, or construction costs will not vary from our statements of probable cost.

Finley Woods Community Development District

3501 Quadrangle Boulevard, Suite 270, Orlando, FL 32817; 407-723-5900

May 27, 2022

Brandon Reynolds
St. Johns River Water Management District
4049 Reid Street
Palatka, Florida 32178

RE: Finley Woods Phase 3 – Operation & Maintenance Plan

Dear Mr. Reynolds,

All Stormwater Management Facilities (SMFs) within the Finley Woods Phase 3 development will be operated and maintained in accordance with the latest City approved plan by Finley Woods Community Development District (CDD), a local governing entity with functions and powers established by City of Gainesville Ordinance No. 180972.

The operation and maintenance plan for Finley Woods Phase 3 Stormwater Management Facility (SMF) - 3 and SMF-4 is included within Appendix B of the associated Stormwater Management System Report. The plan has been attached to this letter for reference.

Sincerely,



Jane Gaarlandt
Finley Woods Community Development District



Finley Woods Community Development District

Consideration of Work Product Acquisition for the Series 2020 Project

A.Resolution 2026-01, Authorizing DSRF Release and Requisition (Series 2020)

RESOLUTION 2026-01

A RESOLUTION OF THE BOARD OF SUPERVISORS OF THE FINLEY WOODS COMMUNITY DEVELOPMENT DISTRICT AUTHORIZING THE RELEASE OF A PORTION OF THE DEBT SERVICE RESERVE FUNDS INTO THE SERIES 2020 ACQUISITION AND CONSTRUCTION ACCOUNT; AUTHORIZING A WORK PRODUCT ACQUISITION AND, UPON COMPLETION OF SUCH ACQUISITION, A REQUISITION FOR PAYMENT OF SUCH WORK PRODUCT FROM THE SERIES 2020 ACQUISITION AND CONSTRUCTION ACCOUNT; PROVIDING ADDITIONAL AUTHORIZATION; AND PROVIDING FOR SEVERABILITY, CONFLICTS, AND AN EFFECTIVE DATE.

WHEREAS, the Finley Woods Community Development District (“**District**”) is a local unit of special purpose government created and existing pursuant to Chapter 190, Florida Statutes; and

WHEREAS, the District previously issued its Capital Improvement Revenue Bonds, Series 2020 (Assessment Area One) (“**Series 2020 Bonds**”) pursuant to that certain *Master Trust Indenture* dated as of February 1, 2020 (“**Master Indenture**”) as supplemented by that certain *First Supplemental Trust Indenture* dated as of February 1, 2020 (“**Supplemental Indenture**” and together with the Master Indenture, “**Indenture**”) in order to finance the District’s “**Series 2020 Project**”;¹ and

WHEREAS, in connection with the issuance of the Series 2020 Bonds and pursuant to the Indenture, certain monies in the amount of Series 2020 Reserve Account Requirement were originally placed in the Series 2020 Reserve Account for the protection of the holders of the Series 2020 Bonds until the following Conditions for Reduction of Reserve Account Requirement were met, all as further detailed in the Supplemental Indenture:

“Conditions for Reduction of Reserve Account Requirement” shall mean, collectively, that (i) all lots subject to Series 2020 Assessments have been developed and platted, (ii) all lots subject to Series 2020 Assessments have been sold by the Developer to builders and all such sales have closed, and (iii) there are no Events of Default occurring or continuing under the Indenture with respect to the Series 2020 Bonds. The District Engineer shall provide a written certification to the District and the Trustee certifying that the event in clause (i) has occurred and the District Manager shall provide a written certification to the District and the Trustee certifying that the event in clause (ii) has occurred and affirming clause (iii), on which certifications the Trustee may conclusively rely. (for purposes of this Resolution, hereinafter referred to as “**Release Conditions**”).

WHEREAS, the Release Conditions, once satisfied, will trigger the release of an amount equal to 50% of the Maximum Annual Debt Service Requirement for all Outstanding Series 2020 Bonds, as of the time of any such calculation (“**Released Proceeds**”) from the Series 2020 Reserve Account into the Series 2020 Acquisition and Construction Account; and

¹ Terms not otherwise defined in this resolution shall have the meanings ascribed to them by the Indenture.

WHEREAS, as further provided in the Indenture, prior to the Date of Completion of the Series 2020 Project,² upon the satisfaction of the Release Conditions the Released Proceeds shall be deposited into the Series 2020 Acquisition and Construction Account and, together with any other amounts in the Series 2020 Acquisition and Construction Account (such amounts together with the Released Proceeds, the “**Additional Construction Proceeds**”), applied to pay the Costs of the Series 2020 Project; and

WHEREAS, in connection with the issuance of Series 2020 Bonds, Finley Woods Development, LLC (“**Developer**”) is required to contribute \$772,257 in funds or CIP infrastructure components to the District in order to satisfy its Contribution requirement, as defined in and further provided the Assessment Methodology; and

WHEREAS, the District desires to acquire from the Developer the engineering, site plan, and other work product associated with the previously acquired and constructed Series 2020 Project improvements (collectively, “**Work Product**”), which is part of the Series 2020 Project as provided in the District’s capital improvement plan reports, in an amount that is lesser of an estimated not to exceed value of \$ [REDACTED] or the actual costs paid for same by the Developer (“**Unpaid Amount**”), and the Board desires to utilize a portion of such acquisition to recognize the Developer’s satisfaction of Contribution requirement and to pay the remainder of acquisition costs from Additional Construction Proceeds; and

WHEREAS, the District further authorizes a requisition be prepared pursuant to the terms of the Supplemental Indenture in order to fund the remaining unreimbursed portion of the Unpaid Amount (excluding Contribution recognized) from the Additional Construction Proceeds.

NOW, THEREFORE, BE IT RESOLVED BY THE BOARD OF SUPERVISORS OF THE FINLEY WOODS COMMUNITY DEVELOPMENT DISTRICT:

1. RECITALS. The foregoing recitals are incorporated herein as true and correct findings of the District’s Board of Supervisors.

2. RECOGNITION OF CONTRIBUTION. The District hereby recognizes, accepts, and acknowledges \$772,257 of the Unpaid Amount as Contribution. The District hereby acknowledges that the same satisfies the Developer’s Contribution requirement in full as provided in the Assessment Methodology.

3. AUTHORIZATION FOR RESERVES RELEASE. Upon receipt of applicable certificates per Indenture requirements confirming the satisfaction of the Release Conditions, the District hereby authorizes District staff to request to the Trustee that the Trustee transfer the Released Proceeds from the Series 2020 Reserve Account to the Series 2020 Acquisition and Construction Account per Indenture terms.

4. AUTHORIZATION FOR ACQUISITION AND SUBSEQUENT REQUISITION. The District hereby authorizes District staff to acquire the Work Product in an amount not to exceed \$ [REDACTED]. Furthermore, the District hereby authorizes a requisition for payment to the Developer of the remainder of Unpaid Amount (excluding Contribution), to the extent of available

² The Series 2020 Project, which consists of the public improvements in Phases 1C and 2, has not yet been declared complete by the District.

Additional Construction Proceeds, in substantially the form provided in the Indenture, to be submitted to the Trustee once the Released Proceeds have been transferred from the Series 2020 Reserve Account to the Series 2020 Acquisition and Construction Account.

5. GENERAL AUTHORIZATION; RATIFICATION OF PRIOR ACTIONS. The Chairman, members of the Board of Supervisors, and District staff are hereby generally authorized, upon the adoption of this Resolution, to do all acts and things required of them by this Resolution or desirable or consistent with the requirements or intent hereof. To the extent the Chairman, members of the Board of Supervisors, and District staff have taken certain preliminary actions to date to effectuate transactions contemplated by this Resolution, such actions are hereby ratified, confirmed, and approved.

6. CONFLICTS. All District resolutions or parts thereof in conflict herewith are, to the extent of such conflict, superseded and repealed.

7. SEVERABILITY. If any section or part of a section of this Resolution is declared invalid or unconstitutional, the validity, force and effect of any other section or part of a section of this Resolution shall not thereby be affected or impaired unless it clearly appears that such other section or part of a section of this Resolution is wholly or necessarily dependent upon the section or part of a section so held to be invalid or unconstitutional.

8. EFFECTIVE DATE. This Resolution shall take effect immediately upon its adoption.

PASSED AND ADOPTED this 12th day of February 2026.

ATTEST:

**FINLEY WOODS COMMUNITY
DEVELOPMENT DISTRICT**

Secretary / Asst. Secretary

By: _____
Its: _____



Finley Woods Community Development District

**Consideration of Funding Request
Nos. 93 - 100**

**FINLEY WOODS
COMMUNITY DEVELOPMENT DISTRICT**

Funding Request No. 93
10/15/2025

Invoice No	Supplier	Invoice Date	Property	Invoice Amount
0007302945	Gannett Florida LocaliQ (FINLEY)	08/31/2025	Finley Woods CDD	142.22
7350821	Gannett Florida LocaliQ (FINLEY)	09/30/2025	Finley Woods CDD	328.72
3627298	Kutak Rock LLP (FINLEY)	09/25/2025	Finley Woods CDD	1,101.65
138229	PFM Group Consulting LLC (FINLEY)	09/29/2025	Finley Woods CDD	1,250.00
Total:				2,822.59

Board Member

Please Return To:
Finley Woods CDD
c/o PFM Group Consulting LLC
3501 Quadrangle Boulevard, Ste. 270
Orlando, FL 32817



ACCOUNT NAME		ACCOUNT #	INV DATE
Finley Woods CDD		624816	08/31/25
INVOICE #	INVOICE PERIOD	CURRENT INVOICE TOTAL	
0007302945	Aug 1- Aug 31, 2025	\$142.22	
PREPAY (Memo Info)	UNAPPLIED (included in amt due)	TOTAL CASH AMT DUE*	
\$0.00	\$0.00	\$142.22	

BILLING ACCOUNT NAME AND ADDRESS	PAYMENT DUE DATE: SEPTEMBER 30, 2025
Finley Woods CDD 3501 Quadrangle BLVD # 270 Orlando, FL 32817-8329	<p>Legal Entity: Gannett Media Corp.</p> <p>Terms and Conditions: Past due accounts are subject to interest at the rate of 18% per annum or the maximum legal rate (whichever is less). Advertiser claims for a credit related to rates incorrectly invoiced or paid must be submitted in writing to Publisher within 30 days of the invoice date or the claim will be waived. Any credit towards future advertising must be used within 30 days of issuance or the credit will be forfeited.</p> <p>All funds payable in US dollars.</p>

BILLING INQUIRIES/ADDRESS CHANGES 1-877-736-7612 or smb@ccc.gannett.com **FEDERAL ID** 47-2390983

Save A Tree! Gannett is going paperless. Enjoy the convenience of accessing your billing information anytime and pay online. To avoid missing an invoice, sign up today by going to <https://gcil.my.site.com/financialservicesportal/s/>.

Date	Description	Amount
8/1/25	Balance Forward	\$1,848.32
8/5/25	PAYMENT - THANK YOU	-\$154.52
8/19/25	PAYMENT- THANK YOU	-\$1,693.80

Package Advertising:

Start-End Date	Order Number	Product	Description	PO Number	Package Cost
8/26/25	11593439	GAI Gainesville Sun	11593439		\$142.22

As an incentive for customers, we provide a discount off the total invoice cost equal to the 3.99% service fee if you pay with Cash/Check/ACH. Pay by Cash/Check/ACH and Save!

Total Cash Amount Due	\$142.22
Service Fee 3.99%	\$5.67
*Cash/Check/ACH Discount	-\$5.67
*Payment Amount by Cash/Check/ACH	\$142.22
Payment Amount by Credit Card	\$147.89

PLEASE DETACH AND RETURN THIS PORTION WITH YOUR PAYMENT

ACCOUNT NAME		ACCOUNT NUMBER		INVOICE NUMBER		AMOUNT PAID
Finley Woods CDD		624816		0007302945		
CURRENT DUE	30 DAYS PAST DUE	60 DAYS PAST DUE	90 DAYS PAST DUE	120+ DAYS PAST DUE	UNAPPLIED PAYMENTS	TOTAL CASH AMT DUE*
\$142.22	\$0.00	\$0.00	\$0.00	\$0.00	\$0.00	\$142.22
REMITTANCE ADDRESS (Include Account# & Invoice# on check)				TO PAY BY PHONE PLEASE CALL:		TOTAL CREDIT CARD AMT DUE
Gannett Florida LocaliQ PO Box 631244 Cincinnati, OH 45263-1244				1-877-736-7612		\$147.89
				To sign up for E-mailed invoices and online payments please go to https://gcil.my.site.com/financialservicesportal/s/		

00006248160000000000000073029450001422267176



ACCOUNT NAME		ACCOUNT #	INV DATE
Finley Woods CDD		624816	09/30/25
INVOICE #	INVOICE PERIOD	CURRENT INVOICE TOTAL	
0007350821	Sep 1- Sep 30, 2025	\$328.72	
PREPAY (Memo Info)	UNAPPLIED (included in amt due)	TOTAL CASH AMT DUE*	
\$0.00	\$0.00	\$470.94	

BILLING ACCOUNT NAME AND ADDRESS	PAYMENT DUE DATE: OCTOBER 31, 2025
Finley Woods CDD 3501 Quadrangle BLVD # 270 Orlando, FL 32817-8329	<p>Legal Entity: Gannett Media Corp.</p> <p>Terms and Conditions: Past due accounts are subject to interest at the rate of 18% per annum or the maximum legal rate (whichever is less). Advertiser claims for a credit related to rates incorrectly invoiced or paid must be submitted in writing to Publisher within 30 days of the invoice date or the claim will be waived. Any credit towards future advertising must be used within 30 days of issuance or the credit will be forfeited.</p> <p>All funds payable in US dollars.</p>

BILLING INQUIRIES/ADDRESS CHANGES 1-877-736-7612 or smb@ccc.gannett.com **FEDERAL ID** 47-2390983

Save A Tree! Gannett is going paperless. Enjoy the convenience of accessing your billing information anytime and pay online. To avoid missing an invoice, sign up today by going to <https://gcil.my.site.com/financialservicesportal/s/>.

Date	Description	Amount
9/1/25	Balance Forward	\$142.22

Package Advertising:

Start-End Date	Order Number	Product	Description	PO Number	Package Cost
9/16/25	11638717	GAI Gainesville Sun	Finley Woods - Notice of BOS Meeting 9.23.25	BOS MTG 9.23.25	\$156.98
9/30/25	11648991	GAI Gainesville Sun	Finley Woods CDD BOS Meetings		\$171.74

As an incentive for customers, we provide a discount off the total invoice cost equal to the 3.99% service fee if you pay with Cash/Check/ACH. Pay by Cash/Check/ACH and Save!

Total Cash Amount Due	\$470.94
Service Fee 3.99%	\$18.79
*Cash/Check/ACH Discount	-\$18.79
*Payment Amount by Cash/Check/ACH	\$470.94
Payment Amount by Credit Card	\$489.73

PLEASE DETACH AND RETURN THIS PORTION WITH YOUR PAYMENT

ACCOUNT NAME		ACCOUNT NUMBER		INVOICE NUMBER		AMOUNT PAID
Finley Woods CDD		624816		0007350821		
CURRENT DUE	30 DAYS PAST DUE	60 DAYS PAST DUE	90 DAYS PAST DUE	120+ DAYS PAST DUE	UNAPPLIED PAYMENTS	TOTAL CASH AMT DUE*
\$328.72	\$142.22	\$0.00	\$0.00	\$0.00	\$0.00	\$470.94
REMITTANCE ADDRESS (Include Account# & Invoice# on check)				TO PAY BY PHONE PLEASE CALL:		TOTAL CREDIT CARD AMT DUE
Gannett Florida LocaliQ PO Box 631244 Cincinnati, OH 45263-1244				1-877-736-7612		\$489.73
				To sign up for E-mailed invoices and online payments please go to https://gcil.my.site.com/financialservicesportal/s/		

000062481600000000000000073508210004709467179

KUTAK ROCK LLP

TALLAHASSEE, FLORIDA

Telephone 404-222-4600

Facsimile 404-222-4654

Federal ID 47-0597598

September 25, 2025

Check Remit To:

Kutak Rock LLP

PO Box 30057

Omaha, NE 68103-1157



Notification Email: eftgroup@kutakrock.com

Ms. Jane Gaarlandt
Finley Woods CDD
PFM Group Consulting, LLC
12051 Corporate Boulevard
Orlando, FL 32817

Invoice No. 3627298
8323-1

Re: General Counsel

For Professional Legal Services Rendered

07/01/25	M. Rigoni	1.40	392.00	Prepare for board meeting and confer with Kerr; confer with Patterson regarding property conveyance; attend board meeting
07/03/25	J. Gillis	0.70	112.00	Coordinate recording of special warranty deed for Phases 1C and 2 common areas; disseminate recorded copy; compile acquisition documents and prepare updates to property due diligence chart; confer with staff regarding same
07/03/25	M. Rigoni	0.30	84.00	Review executed property acquisition documents and confer with Lasky and Gillis regarding same
07/08/25	K. Haber	0.30	81.00	Correspond with Kerr regarding budget documents

KUTAK ROCK LLP

Finley Woods CDD
September 25, 2025
Client Matter No. 8323-1
Invoice No. 3627298
Page 2

07/29/25	M. Rigoni	1.30	364.00	Confer with Patterson, Gaarlandt, Montejano, and Kerr regarding maintenance budget and cost share status; review property due diligence; revise FY 2026 budget funding agreement and confer with Rogers and Gaarlandt
07/30/25	M. Rigoni	0.10	28.00	Confer with Rogers
TOTAL HOURS		4.10		
TOTAL FOR SERVICES RENDERED				\$1,061.00
DISBURSEMENTS				
Filing and Court Fees			40.65	
TOTAL DISBURSEMENTS				<u>40.65</u>
TOTAL CURRENT AMOUNT DUE				<u>\$1,101.65</u>



Date	Invoice Number
September 29, 2025	138229
Payment Terms	Due Date
Upon Receipt	September 29, 2025

Bill To:
Finley Woods CDD
c/o PFM Group Consulting District Accounting
Department
3501 Quadrangle Blvd., Suite 270
Orlando, FL 32817
United States of America

Company Address:
1735 Market Street
42nd Floor
Philadelphia, PA 19103
+1 (215) 5676100

Remittance Options:

Via Mail:

PFM Group Consulting LLC
PO Box 65126
Baltimore, MD 21264-5126
United States of America

RE: Quarterly Disclosure for the period of 07.01.25 - 09.30.25

Bond Issue 2020

\$1,250.00

Total Amount Due

\$1,250.00

**FINLEY WOODS
COMMUNITY DEVELOPMENT DISTRICT**

Funding Request No. 94
10/28/2025

Invoice No	Supplier	Invoice Date	Fiscal Year	Invoice Amount
93456	FloridaCommerce (FINLEY)	10/01/2025	FY 2026	175.00
DM-10-2025-18	PFM Group Consulting LLC (FINLEY)	10/01/2025	FY 2026	2,083.33
7714	VGlobalTech (FINLEY)	09/30/2025	FY 2025	300.00
7801	VGlobalTech (FINLEY)	10/01/2025	FY 2026	145.00
Total:				2,703.33

Board Member

Please Return To:
Finley Woods CDD
c/o PFM Group Consulting LLC
3501 Quadrangle Boulevard, Ste. 270
Orlando, FL 32817



Transaction Confirmation and Receipt

[Print this page for your records.](#)

Special District:	Finley Woods Community Development District
Transaction No:	235129708
Payment Date:	10/14/2025
Invoice Number:	93456
Amount Paid:	175.00
Full Name:	Rick Montejano
Address:	3501 Quadrangle Blvd. Ste. 270 Orlando, Florida 32817
Phone Number:	407-723-5951
Email Address:	montejanor@pfn.com

Prepare and Provide Your Annual Update

To ensure that the Official List of Special Districts remains up-to-date, complete the annual update process as follows, even if no changes are necessary.

Steps:

1. Review the information on the Special District State Fee Invoice and Profile Update document.
2. Mark any changes directly on the document.
3. Write "Paid online" and the date paid directly on the document.
4. Sign and Date the document
5. Email the document to SpecialDistricts@Commerce.fl.gov or mail it to:

**Florida Department of Economic Opportunity
Bureau of Budget Management
107 East Madison Street, MSC 120
Tallahassee, Florida 32399-4124**

FloridaCommerce, Special District Accountability Program

Fiscal Year 2025 - 2026 Special District State Fee Invoice and Profile Update

Required by sections 189.064 and 189.018, Florida Statutes, and Chapter 73C-24, Florida Administrative Code

Date Invoiced: 10/01/2025				Invoice No: 93456
Annual Fee: \$175.00	1st Late Fee: \$0.00	2nd Late Fee: \$0.00	Received: \$0.00	Total Due, Postmarked by 12/02/2025: \$175.00

STEP 1: Review the following profile and make any needed changes.

1. Special District's Name, Registered Agent's Name and Registered Office Address:

Finley Woods Community Development District
 Ms. Katie S. Buchanan
 Kutak Rock LLP
 107 West College Avenue
 Tallahassee, Florida 32301



- 2. Telephone:** 850-692-7300 Ext:
- 3. Fax:** 850-692-7319
- 4. Email:** Katie.Buchanan@KutakRock.com
- 5. Status:** Independent
- 6. Governing Body:** Elected
- 7. Website Address:** www.finleywoodscdd.com
- 8. County(ies):** Alachua
- 9. Special Purpose(s):** Community Development
- 10. Boundary Map on File:** 09/20/2019
- 11. Creation Document on File:** 09/20/2019
- 12. Date Established:** 08/01/2019
- 13. Creation Method:** Local Ordinance
- 14. Local Governing Authority:** City of Gainesville
- 15. Creation Document(s):** City Ordinance 180972
- 16. Statutory Authority:** Chapter 190, Florida Statutes
- 17. Authority to Issue Bonds:** Yes
- 18. Revenue Source(s):** Assessments

STEP 2: Sign and date to certify accuracy and completeness.

By signing and dating below, I do hereby certify that the profile above (changes noted if necessary) is accurate and complete:

Registered Agent's Signature: Katie S. Buchanan Date 10.9.2025

STEP 3: Pay the annual state fee or certify eligibility for zero annual fee.

a. Pay the Annual Fee: Pay the annual fee by following the instructions at www.FloridaJobs.org/SpecialDistrictFee.

b. Or, Certify Eligibility for the Zero Fee: By initialing both of the following items, I, the above signed registered agent, do hereby certify that to the best of my knowledge and belief, **BOTH** of the following statements and those on any submissions to the Department are true, correct, complete, and made in good faith. I understand that any information I give may be verified.

1. ___ This special district is not a component unit of a general purpose local government as determined by the special district and its Certified Public Accountant; and,

2. ___ This special district is in compliance with its Fiscal Year 2023 - 2024 Annual Financial Report (AFR) filing requirement with the Florida Department of Financial Services (DFS) and that AFR reflects \$3,000 or less in annual revenues or, is a special district not required to file a Fiscal Year 2023 - 2024 AFR with DFS and has included an income statement with this document verifying \$3,000 or less in revenues for the current fiscal year.

Department Use Only: Approved: ___ Denied: ___ Reason: _____

STEP 4: Make a copy of this document for your records.

STEP 5: Email this document to SpecialDistricts@Commerce.fl.gov or mail it to FloridaCommerce, Bureau of Budget Management, 107 East Madison Street, MSC #120, Tallahassee, FL 32399-4124. Direct questions to 850.717.8430.



Date	Invoice Number
October 1, 2025	DM-10-2025-18
Payment Terms	Due Date
Upon Receipt	October 1, 2025

Bill To:
Finley Woods CDD
c/o PFM Group Consulting District Accounting
Department
3501 Quadrangle Blvd., Suite 270
Orlando, FL 32817
United States of America

Company Address:
1735 Market Street
42nd Floor
Philadelphia, PA 19103
+1 (215) 5676100

Remittance Options:

Via Mail:

PFM Group Consulting LLC
PO Box 65126
Baltimore, MD 21264-5126
United States of America

RE: District Management Fee: October 2025

Professional Fees	\$2,083.33
Total Amount Due	\$2,083.33

VGlobalTech
636 Fanning Drive
Winter Springs, FL 32708 US
contact@vglobaltech.com
www.vglobaltech.com



INVOICE

BILL TO

Finley Woods CDD
3501 Quadrangle Blvd.,
Suite 270,
Orlando, FL 32817

INVOICE # 7714

DATE 09/30/2025

DUE DATE 09/30/2025

TERMS Due on receipt

DATE	ACTIVITY	QTY	RATE	AMOUNT
	Audits:Quarterly ADA & WCAG Audits Quarterly ADA & WCAG Audits for all new content and document conversions for the website.	1	300.00	300.00

Invoice for Quarter 3 ADA Audit.

BALANCE DUE

\$300.00

Please make check payable to VGlobalTech.

VGlobalTech
636 Fanning Drive
Winter Springs, FL 32708 US
contact@vglobaltech.com
www.vglobaltech.com



INVOICE

BILL TO

Finley Woods CDD
3501 Quadrangle Blvd.,
Suite 270,
Orlando, FL 32817

INVOICE # 7801

DATE 10/01/2025

DUE DATE 10/01/2025

TERMS Due on receipt

DATE	ACTIVITY	QTY	RATE	AMOUNT
	Web Maintenance:ADA Website Maintenance Ongoing website maintenance for ADA and WCAG Compliance	1	145.00	145.00

Please make check payable to VGlobalTech.

BALANCE DUE

\$145.00

**FINLEY WOODS
COMMUNITY DEVELOPMENT DISTRICT**

Funding Request No. 95
11/10/2025

Invoice No	Supplier	Invoice Date	Fiscal Year	Invoice Amount
46820-102125	Gainesville Regional Utilities (FINLEY)	10/21/2025	FY 2026	36.36
46921-102125	Gainesville Regional Utilities (FINLEY)	10/21/2025	FY 2026	98.40
47022-102125	Gainesville Regional Utilities (FINLEY)	10/21/2025	FY 2026	36.36
0007405399	Gannett Florida LocaliQ (FINLEY)	10/31/2025	FY 2026	156.98
3626418	Kutak Rock LLP (FINLEY)	09/18/2025	FY 2025	3,287.21
OE-EXP-11-2025-19	PFM Group Consulting LLC (FINLEY)	11/04/2025	FY 2026	1.48
13880	Premier Lawn Care (FINLEY)	10/01/2025	FY 2026	1,800.00
14240	Premier Lawn Care (FINLEY)	11/01/2025	FY 2026	1,800.00
7886	VGlobalTech (FINLEY)	11/01/2025	FY 2026	145.00
Total:				7,361.79

Board Member

Please Return To:
Finley Woods CDD
c/o PFM Group Consulting LLC
3501 Quadrangle Boulevard, Ste. 270
Orlando, FL 32817



Gainesville Regional Utilities
301 S.E. 4th Avenue
Gainesville FL 32601

Account: 2500-0764-6820
Bill Date: 10/21/2025

FINLEY WOODS COMMUNITY DEVELOPMENT

4448 SW 59TH PL
GAINESVILLE FL 32608

507000350591
ROUTE: 191932
NRES

Cash Security Deposit on File is \$220.00

ACCOUNT SUMMARY

Current Month Charges: \$10.56
Adjustments & Service Charges: \$245.80
Balance Forward: -\$220.00

TOTAL AMOUNT DUE \$36.36 DUE BY 11/11/2025

A 1.5% late fee will be charged for new charges not paid by your due date. Service disconnection may result from past due balances.

SUMMARY OF SERVICES

UTILITIES (See reverse for details about your utility charges.)

Water \$9.60
Total Utility Charge \$9.60

TAXES AND SURCHARGES

City of Gainesville Utility Tax \$0.96
Total Taxes and Surcharges \$0.96

TOTAL CURRENT MONTH CHARGES \$10.56

ADJUSTMENTS & SERVICE CHARGES

Turn On Charges \$26.00
Security Deposit \$220.00
Security Deposit Interest -\$0.20
TOTAL ADJUSTMENTS & SERVICE CHARGES \$245.80

PREVIOUS BILL ACTIVITY

Previous Balance \$0.00
Payment Amount (Date: 10/08/2025) -\$220.00
BALANCE FORWARD -\$220.00

AVERAGE DAILY CONSUMPTION

Service	Meter	This Month	Last Month	Last Year
WATER	22048689	0.00	0.00	0.00
AVERAGE TEMPERATURE (High/Low)		87/68	90/72	85/70
MONTHLY RAINFALL (Inches)		3.77	4.51	7.15

MESSAGES

Fat, oil and grease (FOG) poured into drains can cause back-ups and sewage spills. Don't pour FOG down drains or garbage disposals. Instead, pour FOG into closed containers such as coffee cans and dispose of it in garbage bins. Visit gru.com/fog for more information.

Daylight Saving Time ends in November. Adjust your programmable thermostats and check all lighting timers to be sure they are turning interior and exterior lights on and off at appropriate times.

SERVICE AGREEMENT: Use or consumption of services rendered by this City shall constitute an agreement by the consumer with the City to abide by the rules of the City with regards to its utility service, including, but not limited to prevailing ordinances and policies of this City and its departments.

RETURN THIS PAYMENT STUB WITH THE PAYMENT FOR PROPER CREDIT



Gainesville Regional Utilities
301 S.E. 4th Avenue
Gainesville FL 32601

Account Number: 2500-0764-6820
Total Payment Enclosed: \$ _____
TOTAL AMOUNT DUE \$ 36.36

Sign up for eBill, GRU's free online paperless billing service, at gru.com/ebill

Current month charges due on 11/11/2025

007208 000000400



C/O RICK MONTEJANO
FINLEY WOODS COMMUNITY DEVELOPMENT
3501 QUADRANGLE BLVD STE 270
ORLANDO FL 32817-8329



GAINESVILLE REGIONAL UTILITIES
P.O. BOX 147051
GAINESVILLE FL 32614-7051



WATER AND WASTEWATER SERVICE DETAILS

Meter Number	Meter Read Dates Previous	Meter Read Dates Present	Meter Read Type	Days of Service	Meter Readings Previous	Meter Readings Present	Meter Multiplier	Water Consumption	Wastewater Consumption	Next Meter Read on or About
22048689	10/09/2025	10/14/2025	ACTUAL	6	737	737	1.00000	0 kGals	N/A	11/13/2025

Description	Usage	Rate	Amount Billed
WATER CUSTOMER CHARGE		\$9.60	\$9.60
WATER USE	0	\$0.0000	\$0.00
GAINESVILLE WATER UTIL TAX			\$0.96
Total for Water and Wastewater Service Details			\$10.56

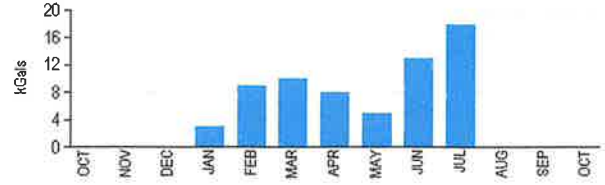

Pay Cash using the payment slip below at a local convenient location in your neighborhood. Check on-line for additional retail establishments.

PAY WITH CASH PAY YOUR GAINESVILLE REGIONAL UTILITIES BILL WITH CASH AT PARTICIPATING RETAILERS

Payments are recognized immediately and are posted the same day.

Bring this barcode with you to make a payment.

RETAILER INSTRUCTIONS:

1. SCAN the customer's barcode.
2. The register will PROMPT you to enter an amount.
3. ENTER the amount the customer wants to pay.
4. COLLECT the desired cash amount (and fee, if applicable).
5. When the transaction is COMPLETE hand customer the receipt.

For Customer Assistance, call (352) 334-3434.

By accepting or using this barcode to make a payment, you agree to the full terms and conditions, available at www.gru.com. After successful payment using this barcode, you may receive your full detailed e-receipt at WATER@GRU.COM.

Create your barcode at <https://myaccount.gru.com/PayNowGuest>, select Cash EZ-PAY from the Pay Bill As A Guest screen.

A \$1.50 fee will be added.

Customer Inquiries

Customer Service	(352) 334-3434	Stormwater Service	(352) 334-5070
Emergency or Outages	(352) 334-2871	Solid Waste Service	(352) 334-2330

Payment Information

Make checks payable to GRU; return stub and check to: P.O. Box 147051, Gainesville, FL 32614-7051. You may also pay your bill online, by phone at 352-393-6886 or at a convenient location in your neighborhood. Visit www.gru.com for details.

Lobby 8 AM - 5 PM: M, T, Th, F and 9 AM - 5 PM: W
 Drive-thru 7:30 AM - 6 PM: M - F

Night depository payments will be posted the next business day if received after 3:30 p.m.

HOW TO READ YOUR METER

Read the dials from left to right (A-E). If the dial hand is between two numbers, use the lower number.

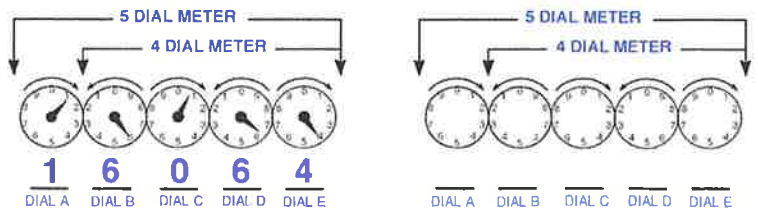



Gainesville Regional Utilities
301 S.E. 4th Avenue
Gainesville FL 32601

Account: 2500-0764-6921
Bill Date: 10/21/2025

FINLEY WOODS COMMUNITY DEVELOPMENT

6085 SW 46TH DR
GAINESVILLE FL 32608

507000350592
ROUTE: 191932
NRES

Cash Security Deposit on File is \$220.00

ACCOUNT SUMMARY

Current Month Charges: \$72.60
Adjustments & Service Charges: \$245.80
Balance Forward: -\$220.00

TOTAL AMOUNT DUE \$98.40 DUE BY 11/11/2025

A 1.5% late fee will be charged for new charges not paid by your due date. Service disconnection may result from past due balances.

SUMMARY OF SERVICES

UTILITIES (See reverse for details about your utility charges.)

Water \$66.00
Total Utility Charge \$66.00

TAXES AND SURCHARGES

City of Gainesville Utility Tax \$6.60
Total Taxes and Surcharges \$6.60

TOTAL CURRENT MONTH CHARGES \$72.60

ADJUSTMENTS & SERVICE CHARGES

Turn On Charges \$26.00
Security Deposit \$220.00
Security Deposit Interest -\$0.20
TOTAL ADJUSTMENTS & SERVICE CHARGES \$245.80

PREVIOUS BILL ACTIVITY

Previous Balance \$0.00
Payment Amount (Date: 10/08/2025) -\$220.00
BALANCE FORWARD -\$220.00

AVERAGE DAILY CONSUMPTION

Service	Meter	This Month	Last Month	Last Year
WATER	22048685	2.41	2.47	0.00
AVERAGE TEMPERATURE (High/Low)		87/68	90/72	85/70
MONTHLY RAINFALL (Inches)		3.77	4.51	7.15

MESSAGES

Fat, oil and grease (FOG) poured into drains can cause back-ups and sewage spills. Don't pour FOG down drains or garbage disposals. Instead, pour FOG into closed containers such as coffee cans and dispose of it in garbage bins. Visit gru.com/fog for more information.

Daylight Saving Time ends in November. Adjust your programmable thermostats and check all lighting timers to be sure they are turning interior and exterior lights on and off at appropriate times.

SERVICE AGREEMENT: Use or consumption of services rendered by this City shall constitute an agreement by the consumer with the City to abide by the rules of the City with regards to its utility service, including, but not limited to prevailing ordinances and policies of this City and its departments.

RETURN THIS PAYMENT STUB WITH THE PAYMENT FOR PROPER CREDIT



Gainesville Regional Utilities
301 S.E. 4th Avenue
Gainesville FL 32601

Account Number: 2500-0764-6921
Total Payment Enclosed: \$ _____
TOTAL AMOUNT DUE \$ 98.40

Current month charges due on 11/11/2025

Sign up for eBill, GRU's free online paperless billing service, at gru.com/ebill

007209 000000400



C/O RICK MONTEJANO
FINLEY WOODS COMMUNITY DEVELOPMENT
3501 QUADRANGLE BLVD STE 270
ORLANDO FL 32817-8329



GAINESVILLE REGIONAL UTILITIES
P.O. BOX 147051
GAINESVILLE FL 32614-7051



WATER AND WASTEWATER SERVICE DETAILS

Meter Number	Meter Read Dates Previous	Meter Read Dates Present	Meter Read Type	Days of Service	Meter Readings Previous	Meter Readings Present	Meter Multiplier	Water Consumption	Wastewater Consumption	Next Meter Read on or About
22048685	10/09/2025	10/14/2025	ACTUAL	6	813	825	1.0000	12 kGals	N/A	11/13/2025
Description			Usage	Rate	Amount Billed					
WATER CUSTOMER CHARGE				\$9.60	\$9.60					
WATER USE			12	\$4.7000	\$56.40					
GAINESVILLE WATER UTIL TAX					\$6.60					
Total for Water and Wastewater Service Details					\$72.60					

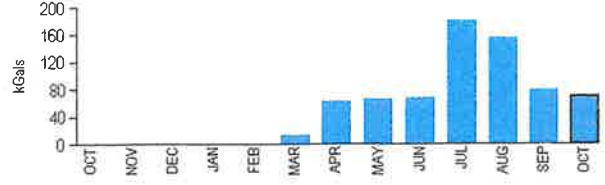

Pay Cash using the payment slip below at a local convenient location in your neighborhood. Check on-line for additional retail establishments.

PAY WITH CASH PAY YOUR GAINESVILLE REGIONAL UTILITIES BILL WITH CASH AT PARTICIPATING RETAILERS

Bring this barcode with you to make a payment.

RETAILER INSTRUCTIONS:

- 1 SCAN the customer's barcode
- 2 The register will PROMPT you to enter an amount
- 3 ENTER the amount the customer wants to pay
- 4 COLLECT the desired cash amount (and fee, if applicable)
- 5 When the transaction is COMPLETE, hand over the receipt

For Customer Assistance, call (352) 334-2434.

By accepting or using this barcode to make a payment, you agree to the full terms and conditions available at myaccount.gru.com/PayNowGuest. After successful payment using this barcode, you may retrieve your full detailed e-receipt at myaccount.gru.com/PayNowGuest.

Create your barcode at <https://myaccount.gru.com/PayNowGuest>, select Cash EZ-PAY from the Pay Bill As A Guest screen

A \$1.50 fee will be added.

Customer Inquiries

Customer Service	(352) 334-3434	Stormwater Service	(352) 334-5070
Emergency or Outages	(352) 334-2871	Solid Waste Service	(352) 334-2330

Payment Information

Make checks payable to GRU; return stub and check to: P.O. Box 147051, Gainesville, FL 32614-7051. You may also pay your bill online, by phone at 352-393-6886 or at a convenient location in your neighborhood. Visit www.gru.com for details.

Lobby 8 AM - 5 PM: M, T, Th, F and 9 AM - 5 PM: W
 Drive-thru 7:30 AM - 6 PM: M - F

Night depository payments will be posted the next business day if received after 3:30 p.m.

HOW TO READ YOUR METER

Read the dials from left to right (A-E). If the dial hand is between two numbers, use the lower number.

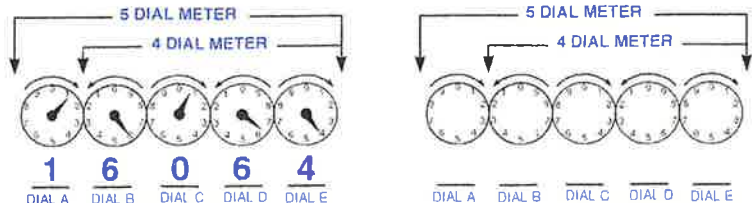



Gainesville Regional Utilities
301 S.E. 4th Avenue
Gainesville FL 32601

Account: 2500-0764-7022
Bill Date: 10/21/2025

FINLEY WOODS COMMUNITY DEVELOPMENT

5830 SW 46TH DR
GAINESVILLE FL 32608

507000350593
ROUTE: 191932
NRES

Cash Security Deposit on File is \$220.00

ACCOUNT SUMMARY

Current Month Charges: \$10.56
Adjustments & Service Charges: \$245.80
Balance Forward: -\$220.00

TOTAL AMOUNT DUE \$36.36 DUE BY 11/11/2025

A 1.5% late fee will be charged for new charges not paid by your due date. Service disconnection may result from past due balances.

SUMMARY OF SERVICES

UTILITIES (See reverse for details about your utility charges.)

Water \$9.60
Total Utility Charge- \$9.60

TAXES AND SURCHARGES

City of Gainesville Utility Tax \$0.96
Total Taxes and Surcharges \$0.96

TOTAL CURRENT MONTH CHARGES \$10.56

ADJUSTMENTS & SERVICE CHARGES

Turn On Charges \$26.00
Security Deposit \$220.00
Security Deposit Interest -\$0.20
TOTAL ADJUSTMENTS & SERVICE CHARGES \$245.80

PREVIOUS BILL ACTIVITY

Previous Balance \$0.00
Payment Amount (Date: 10/08/2025) -\$220.00
BALANCE FORWARD -\$220.00

AVERAGE DAILY CONSUMPTION

Service	Meter	This Month	Last Month	Last Year
WATER	22048833	0.00	0.00	0.62
AVERAGE TEMPERATURE (High/Low)		87/68	90/72	85/70
MONTHLY RAINFALL (Inches)		3.77	4.51	7.15

MESSAGES

Fat, oil and grease (FOG) poured into drains can cause back-ups and sewage spills. Don't pour FOG down drains or garbage disposals. Instead, pour FOG into closed containers such as coffee cans and dispose of it in garbage bins. Visit gru.com/fog for more information.

Daylight Saving Time ends in November. Adjust your programmable thermostats and check all lighting timers to be sure they are turning interior and exterior lights on and off at appropriate times.

SERVICE AGREEMENT: Use or consumption of services rendered by this City shall constitute an agreement by the consumer with the City to abide by the rules of the City with regards to its utility service, including, but not limited to prevailing ordinances and policies of this City and its departments.

RETURN THIS PAYMENT STUB WITH THE PAYMENT FOR PROPER CREDIT



Gainesville Regional Utilities
301 S.E. 4th Avenue
Gainesville FL 32601

Account Number: 2500-0764-7022
Total Payment Enclosed: \$ _____
TOTAL AMOUNT DUE \$ 36.36

Current month charges due on 11/11/2025

Sign up for eBill, GRU's free online paperless billing service, at gru.com/ebill

007210 000000400
C/O RICK MONTEJANO
FINLEY WOODS COMMUNITY DEVELOPMENT
3501 QUADRANGLE BLVD STE 270
ORLANDO FL 32817-8329

GAINESVILLE REGIONAL UTILITIES
P.O. BOX 147051
GAINESVILLE FL 32614-7051



WATER AND WASTEWATER SERVICE DETAILS

Meter Number	Meter Read Dates Previous	Meter Read Dates Present	Meter Read Type	Days of Service	Meter Readings Previous	Meter Readings Present	Meter Multiplier	Water Consumption	Wastewater Consumption	Next Meter Read on or About
22048833	10/09/2025	10/14/2025	ACTUAL	6	846	846	1.00000	0 kGals	N/A	11/13/2025

Description	Usage	Rate	Amount Billed
WATER CUSTOMER CHARGE		\$9.60	\$9.60
WATER USE	0	\$0.0000	\$0.00
GAINESVILLE WATER UTIL TAX			\$0.96
Total for Water and Wastewater Service Details			\$10.56

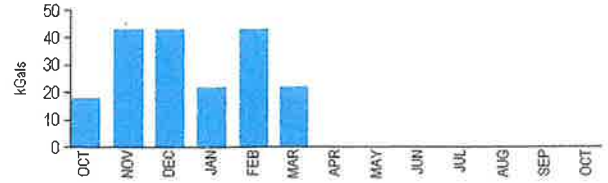

Pay Cash using the payment slip below at a local convenient location in your neighborhood. Check on-line for additional retail establishments.

PAY WITH CASH PAY YOUR GAINESVILLE REGIONAL UTILITIES BILL WITH CASH AT PARTICIPATING RETAILERS

Bring this barcode with you to make a payment.

RETAILER INSTRUCTIONS:

- 1 SCAN the customer's barcode
- 2 The register will PROMPT you to enter an amount
- 3 ENTER the amount the customer wants to pay
- 4 COLLECT the desired cash amount (and fee, if applicable)
- 5 When the transaction is COMPLETE hand customer the receipt

For Customer Assistance, call (352) 334-3434.

By accepting or using this barcode to make a payment, you agree to the full terms and conditions, available at www.gru.com.

After successful payment using this barcode, you may reference your full detailed e-receipt at www.gru.com.

Create your barcode at <https://myaccount.gru.com/PayNowGuest>, select Cash EZ-PAY from the Pay Bill As A Guest screen

A \$1.50 fee will be added.

Customer Inquiries

Customer Service	(352) 334-3434	Stormwater Service	(352) 334-5070
Emergency or Outages	(352) 334-2871	Solid Waste Service	(352) 334-2330

Payment Information

Make checks payable to **GRU**; return stub and check to: P.O. Box 147051, Gainesville, FL 32614-7051. You may also pay your bill online, by phone at 352-393-6886 or at a convenient location in your neighborhood. Visit www.gru.com for details.

Lobby 8 AM - 5 PM: M, T, Th, F and 9 AM - 5 PM: W
 Drive-thru 7:30 AM - 6 PM: M - F

Night depository payments will be posted the next business day if received after 3:30 p.m.

HOW TO READ YOUR METER

Read the dials from left to right (A-E). If the dial hand is between two numbers, use the lower number.

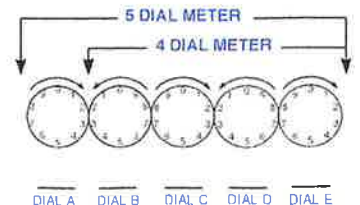
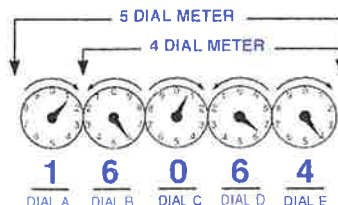



ACCOUNT NAME		ACCOUNT #	INV DATE
Finley Woods CDD		624816	10/31/25
INVOICE #	INVOICE PERIOD	CURRENT INVOICE TOTAL	
0007405399	Oct 1- Oct 31, 2025	\$156.98	
PREPAY (Memo Info)	UNAPPLIED (included in amt due)	TOTAL CASH AMT DUE*	
\$0.00	\$0.00	\$156.98	

BILLING ACCOUNT NAME AND ADDRESS	PAYMENT DUE DATE: NOVEMBER 30, 2025
Finley Woods CDD 3501 Quadrangle BLVD # 270 Orlando, FL 32817-8329	<p>Legal Entity: Gannett Media Corp.</p> <p>Terms and Conditions: Past due accounts are subject to interest at the rate of 18% per annum or the maximum legal rate (whichever is less). Advertiser claims for a credit related to rates incorrectly invoiced or paid must be submitted in writing to Publisher within 30 days of the invoice date or the claim will be waived. Any credit towards future advertising must be used within 30 days of issuance or the credit will be forfeited.</p> <p>All funds payable in US dollars.</p>

BILLING INQUIRIES/ADDRESS CHANGES 1-877-736-7612 or smb@ccc.gannett.com **FEDERAL ID** 47-2390983

Save A Tree! Gannett is going paperless. Enjoy the convenience of accessing your billing information anytime and pay online. To avoid missing an invoice, sign up today by going to <https://gcil.my.site.com/financialservicesportal/s/>.

Date	Description	Amount
10/1/25	Balance Forward	\$470.94
10/23/25	PAYMENT - THANK YOU	-\$142.22
10/23/25	PAYMENT - THANK YOU	-\$328.72

Package Advertising:

Start-End Date	Order Number	Product	Description	PO Number	Package Cost
10/28/25	11776864	GAI Gainesville Sun	Finley Woods - Notice of BOS Meeting 11.4.25		\$156.98

As an incentive for customers, we provide a discount off the total invoice cost equal to the 3.99% service fee if you pay with Cash/Check/ACH. Pay by Cash/Check/ACH and Save!

Total Cash Amount Due	\$156.98
Service Fee 3.99%	\$6.26
*Cash/Check/ACH Discount	-\$6.26
*Payment Amount by Cash/Check/ACH	\$156.98
Payment Amount by Credit Card	\$163.24

PLEASE DETACH AND RETURN THIS PORTION WITH YOUR PAYMENT

ACCOUNT NAME		ACCOUNT NUMBER		INVOICE NUMBER		AMOUNT PAID
Finley Woods CDD		624816		0007405399		
CURRENT DUE	30 DAYS PAST DUE	60 DAYS PAST DUE	90 DAYS PAST DUE	120+ DAYS PAST DUE	UNAPPLIED PAYMENTS	TOTAL CASH AMT DUE*
\$156.98	\$0.00	\$0.00	\$0.00	\$0.00	\$0.00	\$156.98
REMITTANCE ADDRESS (Include Account# & Invoice# on check)				TO PAY BY PHONE PLEASE CALL:		TOTAL CREDIT CARD AMT DUE
Gannett Florida LocaliQ PO Box 631244 Cincinnati, OH 45263-1244				1-877-736-7612		\$163.24
				To sign up for E-mailed invoices and online payments please go to https://gcil.my.site.com/financialservicesportal/s/		

000062481600000000000000074053990001569867170

KUTAK ROCK LLP

TALLAHASSEE, FLORIDA

Telephone 404-222-4600

Facsimile 404-222-4654

Federal ID 47-0597598

September 18, 2025

Check Remit To:

Kutak Rock LLP

PO Box 30057

Omaha, NE 68103-1157



Client Matter No. 8323-1

Notification Email: eftgroup@kutakrock.com

Ms. Jane Gaarlandt
Finley Woods CDD
PFM Group Consulting, LLC
12051 Corporate Boulevard
Orlando, FL 32817

Invoice No. 3626418
8323-1

Re: General Counsel

For Professional Legal Services Rendered

06/02/25	M. Rigoni	0.80	224.00	Prepare for Board meeting
06/03/25	M. Rigoni	4.00	1,120.00	Travel to and attend board meeting; travel back
06/04/25	S. Belcher	0.30	48.00	Quick review of title report; confer with Rigoni regarding same
06/04/25	M. Rigoni	1.10	308.00	Perform meeting follow-up; review property information report for Phase 1C and Tract 2 conveyance; confer with Young, Walpole, Dedenbach, and Patterson regarding project close out items
06/06/25	M. Rigoni	0.20	56.00	Confer with Junkin regarding District Engineering agreement
06/09/25	K. Haber	0.90	229.50	Prepare budget documents
06/09/25	M. Rigoni	0.60	168.00	Review request for estoppel letter and confer with Champagne regarding same; follow up with Patterson and Taylor regarding project close out items
06/10/25	K. Haber	0.20	51.00	Correspond with Gaarlandt regarding budget documents

KUTAK ROCK LLP

Finley Woods CDD
September 18, 2025
Client Matter No. 8323-1
Invoice No. 3626418
Page 2

06/10/25	M. Rigoni	0.10	28.00	Confer with staff regarding outstanding budget documents
06/12/25	M. Rigoni	1.30	364.00	Review proposed budget and confer with Gaarlandt and Montejano; revise remainder of budget documents
06/13/25	M. Rigoni	0.30	84.00	Confer with Montejano regarding revised proposed budget
06/18/25	K. Haber	0.30	76.50	Revise budget funding agreement; correspond with Gaarlandt regarding same
06/30/25	K. Haber	0.50	127.50	Prepare amendment to website maintenance agreement; correspond with Kerr regarding same
06/30/25	M. Rigoni	0.90	252.00	Confer with Gaarlandt and Montejano regarding revised proposed budget and related items

TOTAL HOURS 11.50

TOTAL FOR SERVICES RENDERED \$3,136.50

DISBURSEMENTS

Meals 18.10
Travel Expenses 132.61

TOTAL DISBURSEMENTS 150.71

TOTAL CURRENT AMOUNT DUE \$3,287.21

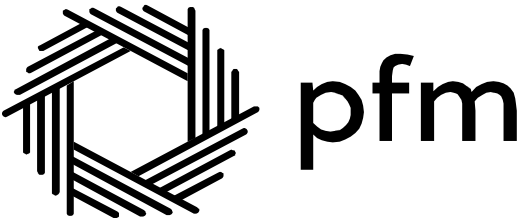

Date	Invoice Number
November 4, 2025	OE-EXP-11-2025-19
Payment Terms	Due Date
Upon Receipt	November 4, 2025

Bill To:
Finley Woods CDD
c/o PFM Group Consulting District Accounting
Department
3501 Quadrangle Blvd., Suite 270
Orlando, FL 32817
United States of America

Company Address:
1735 Market Street
42nd Floor
Philadelphia, PA 19103
+1 (215) 5676100

Remittance Options:

Via Mail:

PFM Group Consulting LLC
PO Box 65126
Baltimore, MD 21264-5126
United States of America

RE: October 2025 Postage \$1.48

Expenses	\$1.48
Total Amount Due	\$1.48



468 Southwest Magnolia Lane | Fort White, Florida 32038
 352-647-7888 | dherring@premierlawncarefl.com |
 www.premierlawncarefl.com

RECIPIENT:

Finley Woods Owners Association
 4809 Southwest 62nd Avenue
 Gainesville, Florida 32608

Invoice #13880	
Issued	Oct 01, 2025
Due	Oct 01, 2025
Total	\$1,800.00

October Lawn Service - Finley Woods Phase II

Product/Service	Description	Total
Lawn Service	Bi Weekly Lawn Service Mowing Edging Trimming Blowing Off	\$1,800.00*

* Non-taxable

Total **\$1,800.00**

Thank You for Your Business. Please contact us with any questions regarding this invoice. We accept all Major Credit Cards, Checks, Cash, Venmo (PremierLawnCareFl)

Pay Now



468 Southwest Magnolia Lane | Fort White, Florida 32038
352-647-7888 | dherring@premierlawncarefl.com |
www.premierlawncarefl.com

RECIPIENT:

Finley Woods CDD
SW 46th Drive
Gainesville, FL 32608

Invoice #14240

Issued	Nov 01, 2025
Due	Nov 01, 2025
Total	\$1,800.00

November Lawn Service

Product/Service	Description	Total
Lawn Service	Mowing of areas on attached Map	\$1,800.00*

* Non-taxable

Total **\$1,800.00**

Thank You for Your Business. Please contact us with any questions regarding this invoice. We accept all Major Credit Cards, Checks, Cash, Venmo (PremierLawnCareFl)

Pay Now

VGlobalTech
636 Fanning Drive
Winter Springs, FL 32708 US
contact@vglobaltech.com
www.vglobaltech.com



INVOICE

BILL TO

Finley Woods CDD
3501 Quadrangle Blvd.,
Suite 270,
Orlando, FL 32817

INVOICE # 7886

DATE 11/01/2025

DUE DATE 11/01/2025

TERMS Due on receipt

DATE	ACTIVITY	QTY	RATE	AMOUNT
	Web Maintenance:ADA Website Maintenance Ongoing website maintenance for ADA and WCAG Compliance	1	145.00	145.00

Please make check payable to VGlobalTech.

BALANCE DUE

\$145.00

Pay invoice

**FINLEY WOODS
COMMUNITY DEVELOPMENT DISTRICT**

Funding Request No. 96
11/25/2025

Invoice No	Supplier	Invoice Date	Fiscal Year	Invoice Amount
452532	NV5 (FINLEY)	09/30/2025	FY 2025	1,530.00
477515	NV5 (FINLEY)	10/15/2025	FY 2025	870.00
139307	PFM Group Consulting LLC (FINLEY)	11/24/2025	FY 2026	7,500.00
DM-11-2025-20	PFM Group Consulting LLC (FINLEY)	11/06/2025	FY 2026	2,083.33
OE-EXP-09-2025-09	PFM Group Consulting LLC (FINLEY)	09/03/2025	FY 2025	1.48
Total:				11,984.81

Board Member

Please Return To:
Finley Woods CDD
c/o PFM Group Consulting LLC
3501 Quadrangle Boulevard, Ste. 270
Orlando, FL 32817

Invoice



Federal Tax ID# 27-1979486

Remit checks to:
NV5, Inc.
PO Box 74008680
Chicago, IL 60674-8680

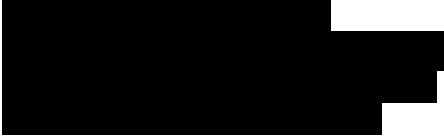

Finley Woods CDD
12051 Corporate Boulevard
Orlando, FL 32817

June 06, 2025
Project No: 1510719-0036007.00
Invoice No: 452532
Due Date: July 06, 2025

Project 1510719-0036007.00 Finley Woods CDD
May:
CDD Coordination
Phase 2 Pay App review

Professional Services from April 27, 2025 to May 24, 2025
Professional Personnel

	Hours	Rate	Amount	
Principal Professional Engineer	5.00	290.00	1,450.00	
Construction PM/CEI Project Admin	.50	160.00	80.00	
Totals	5.50		1,530.00	
Total Labor				1,530.00
		Total this Invoice		1,530.00

Invoice



Federal Tax ID# 27-1979486

Remit checks to:
NV5, Inc.
PO Box 74008680
Chicago, IL 60674-8680

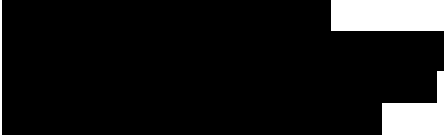
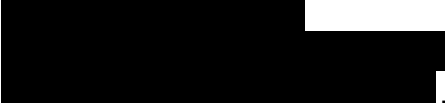

Email ACH/Wire remittance details to
RemittanceNotifications@nv5.com

Finley Woods CDD
12051 Corporate Boulevard
Orlando, FL 32817

October 15, 2025
Project No: 1510719-0036007.00
Invoice No: 477515
Due Date: November 14, 2025

Project 1510719-0036007.00 Finley Woods CDD
Sept 2025:
CDD Meeting Attendance
Coordination with CDD Attorney

Professional Services from August 31, 2025 to September 27, 2025

Professional Personnel

	Hours	Rate	Amount	
Principal Professional Engineer	3.00	290.00	870.00	
Totals	3.00		870.00	
Total Labor				870.00
		Total this Invoice		870.00

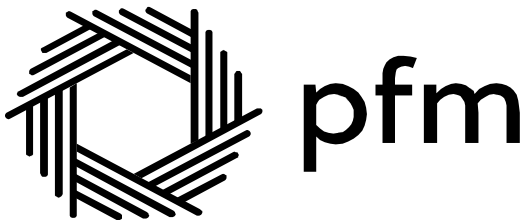

Date	Invoice Number
November 24, 2025	139307
Payment Terms	Due Date
Upon Receipt	November 24, 2025

Bill To:
Finley Woods CDD
c/o PFM Group Consulting District Accounting
Department
3501 Quadrangle Blvd., Suite 270
Orlando, FL 32817
United States of America

Company Address:
1735 Market Street
42nd Floor
Philadelphia, PA 19103
+1 (215) 5676100

Remittance Options:

Via Mail:

PFM Group Consulting LLC
PO Box 65126
Baltimore, MD 21264-5126
United States of America

RE: For the preparation and remittance of the FY2026 Tax Roll.

Professional Fees	\$7,500.00
Total Amount Due	\$7,500.00

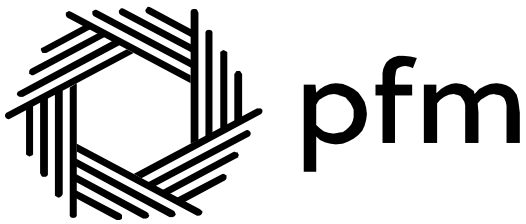

Date	Invoice Number
November 6, 2025	DM-11-2025-20
Payment Terms	Due Date
Upon Receipt	November 6, 2025

Bill To:
Finley Woods CDD
c/o PFM Group Consulting District Accounting
Department
3501 Quadrangle Blvd., Suite 270
Orlando, FL 32817
United States of America

Company Address:
1735 Market Street
42nd Floor
Philadelphia, PA 19103
+1 (215) 5676100

Remittance Options:

Via Mail:

PFM Group Consulting LLC
PO Box 65126
Baltimore, MD 21264-5126
United States of America

RE: District Management Fee: November 2025

Professional Fees	\$2,083.33
Total Amount Due	\$2,083.33



Date	Invoice Number
September 3, 2025	OE-EXP-09-2025-09
Payment Terms	Due Date
Upon Receipt	September 3, 2025

Bill To:
Finley Woods CDD
c/o PFM Group Consulting District Accounting
Department
3501 Quadrangle Blvd., Suite 270
Orlando, FL 32817
United States of America

Company Address:
1735 Market Street
42nd Floor
Philadelphia, PA 19103
+1 (215) 5676100

Remittance Options:

Via Mail:

PFM Group Consulting LLC
PO Box 65126
Baltimore, MD 21264-5126
United States of America

RE: August 2025 Postage \$1.48

Expenses	\$1.48
Total Amount Due	\$1.48

**FINLEY WOODS
COMMUNITY DEVELOPMENT DISTRICT**

Funding Request No. 97
12/9/2025

Invoice No	Supplier	Invoice Date	Property	Invoice Amount
46820-112025	Gainesville Regional Utilities (FINLEY)	11/20/2025	Finley Woods CDD	11.08
46921-112025	Gainesville Regional Utilities (FINLEY)	11/20/2025	Finley Woods CDD	388.97
47022-112025	Gainesville Regional Utilities (FINLEY)	11/20/2025	Finley Woods CDD	11.08
0007455770	Gannett Florida LocaliQ (FINLEY)	11/30/2025	Finley Woods CDD	154.52
3669599	Kutak Rock LLP (FINLEY)	12/04/2025	Finley Woods CDD	2,328.00
DM-12-2025-21	PFM Group Consulting LLC (FINLEY)	12/01/2025	Finley Woods CDD	2,083.33
Total:				4,976.98

Board Member

Please Return To:
Finley Woods CDD
c/o PFM Group Consulting LLC
3501 Quadrangle Boulevard, Ste. 270
Orlando, FL 32817



Gainesville Regional Utilities
301 S.E. 4th Avenue
Gainesville FL 32601

Account: 2500-0764-6820
Bill Date: 11/20/2025

FINLEY WOODS COMMUNITY DEVELOPMENT

4448 SW 59TH PL
GAINESVILLE FL 32608

510000363679
ROUTE: 191932
NRES

Cash Security Deposit on File is \$220.00

SUMMARY OF SERVICES

UTILITIES (See reverse for details about your utility charges.)

Water \$9.60
Total Utility Charge \$9.60

TAXES AND SURCHARGES

City of Gainesville Utility Tax \$0.96
Total Taxes and Surcharges \$0.96

TOTAL CURRENT MONTH CHARGES \$10.56

ADJUSTMENTS & SERVICE CHARGES

Late Fee \$1.00
Security Deposit Interest -\$0.48
TOTAL ADJUSTMENTS & SERVICE CHARGES \$0.52

PREVIOUS BILL ACTIVITY

Previous Balance \$36.36
BALANCE FORWARD \$36.36

ACCOUNT SUMMARY

Current Month Charges: \$10.56 **DUE BY 12/11/2025**
Adjustments & Service Charges: \$0.52
Balance Forward: \$36.36 **DUE IMMEDIATELY**

TOTAL AMOUNT DUE \$47.44

A 1.5% late fee will be charged for new charges not paid by your due date. Service disconnection may result from past due balances.

AVERAGE DAILY CONSUMPTION

Service	Meter	This Month	Last Month	Last Year
WATER	22048689	0 00	0 00	0.00
AVERAGE TEMPERATURE (High/Low)		78/53	87/68	80/60
MONTHLY RAINFALL (Inches)		1 27	3 77	0 16

MESSAGES

Irrigation rules change during Eastern Standard Time. Businesses should irrigate only on Tuesdays. For irrigation tips and water-saving ideas visit gru.com/savewater.

SERVICE AGREEMENT: Use or consumption of services rendered by this City shall constitute an agreement by the consumer with the City to abide by the rules of the City with regards to its utility service, including, but not limited to prevailing ordinances and policies of this City and its departments.

RETURN THIS PAYMENT STUB WITH THE PAYMENT FOR PROPER CREDIT



Gainesville Regional Utilities
301 S.E. 4th Avenue
Gainesville FL 32601

Account Number: 2500-0764-6820
Total Payment Enclosed: \$ _____
TOTAL AMOUNT DUE \$ 47.44

Sign up for eBill, GRU's free online paperless billing service, at gru.com/ebill

Pay past due balance immediately to avoid possible service interruption

004596 000000299



C/O RICK MONTEJANO
FINLEY WOODS COMMUNITY DEVELOPMENT
3501 QUADRANGLE BLVD STE 270
ORLANDO FL 32817-8329



GAINESVILLE REGIONAL UTILITIES
P.O. BOX 147051
GAINESVILLE FL 32614-7051

WATER AND WASTEWATER SERVICE DETAILS

Meter Number	Meter Read Dates Previous	Meter Read Dates Present	Meter Read Type	Days of Service	Meter Readings Previous	Meter Readings Present	Meter Multiplier	Water Consumption	Wastewater Consumption	Next Meter Read on or About
22048689	10/15/2025	11/13/2025	ACTUAL	30	737	737	1.00000	0 kGals	N/A	12/12/2025

Description	Usage	Rate	Amount Billed
WATER CUSTOMER CHARGE		\$9.60	\$9.60
WATER USE	0	\$0.0000	\$0.00
GAINESVILLE WATER UTIL TAX			\$0.96
Total for Water and Wastewater Service Details			\$10.56

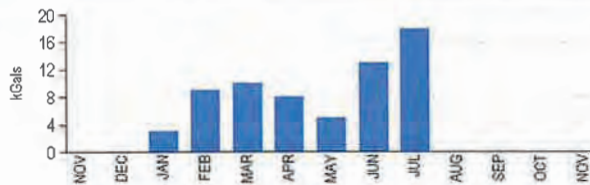

Pay Cash using the payment slip below at a local convenient location in your neighborhood. Check on-line for additional retail establishments.

Customer Inquiries

Customer Service	(352) 334-3434	Stormwater Service	(352) 334-5070
Emergency or Outages	(352) 334-2871	Solid Waste Service	(352) 334-2330

Payment Information

Make checks payable to **GRU**; return stub and check to: P.O. Box 147051, Gainesville, FL 32614-7051. You may also pay your bill online, by phone at 352-393-6886 or at a convenient location in your neighborhood. Visit www.gru.com for details.

Lobby 8 AM - 5 PM: M, T, Th, F and 9 AM - 5 PM: W
 Drive-thru 7:30 AM - 6 PM: M - F

Night depository payments will be posted the next business day if received after 3:30 p.m.

HOW TO READ YOUR METER

Read the dials from left to right (A-E). If the dial hand is between two numbers, use the lower number.

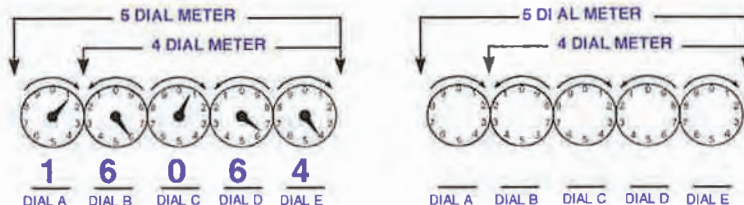

PAY WITH CASH PAY YOUR GAINESVILLE REGIONAL UTILITIES BILL WITH CASH AT PARTICIPATING RETAILERS

Bring this barcode with you to make a payment.

RETAILER INSTRUCTIONS:

- 1 SCAN the customer's barcode
- 2 The register will PROMPT you to enter an amount.
- 3 ENTER the amount the customer wants to pay
- 4 COLLECT the desired cash amount (and fee, if applicable)
- 5 When the transaction is COMPLETE hand customer the receipt

For Customer Assistance, call (352) 334-3434.

By accepting or using this barcode to make a payment, you agree to the full terms and conditions, available at www.gru.com

After successful payment using this barcode, you may retrieve your full detailed e-receipt at www.gru.com

79936600399006371683644047897

A \$1.50 fee will be added.

Participating Retailers: DOLLAR GENERAL, Walgreens, FAMILY DOLLAR, Walmart, HEBB'S FINANCIAL, Available at Service Desk or Money Center, CVS, 7-Eleven.



Gainesville Regional Utilities
301 S.E. 4th Avenue
Gainesville FL 32601

Account: 2500-0764-6921
Bill Date: 11/20/2025

FINLEY WOODS COMMUNITY DEVELOPMENT
6085 SW 46TH DR
GAINESVILLE FL 32608

510000363680
ROUTE: 191932
NRES

Cash Security Deposit on File is \$220.00

SUMMARY OF SERVICES

UTILITIES (See reverse for details about your utility charges.)

Water \$352.70
Total Utility Charge **\$352.70**

TAXES AND SURCHARGES

City of Gainesville Utility Tax \$35.27
Total Taxes and Surcharges **\$35.27**

TOTAL CURRENT MONTH CHARGES \$387.97

ADJUSTMENTS & SERVICE CHARGES

Late Fee \$1.48
Security Deposit Interest -\$0.48
TOTAL ADJUSTMENTS & SERVICE CHARGES **\$1.00**

PREVIOUS BILL ACTIVITY

Previous Balance \$98.40
BALANCE FORWARD **\$98.40**

ACCOUNT SUMMARY

Current Month Charges: \$387.97 **DUE BY 12/11/2025**
Adjustments & Service Charges: \$1.00
Balance Forward: \$98.40 **DUE IMMEDIATELY**

TOTAL AMOUNT DUE \$487.37

A 1.5% late fee will be charged for new charges not paid by your due date. Service disconnection may result from past due balances.

AVERAGE DAILY CONSUMPTION

Service	Meter	This Month	Last Month	Last Year
WATER	22048685	2.43	2.41	0.00
AVERAGE TEMPERATURE (High/Low)		78/53	87/68	80/60
MONTHLY RAINFALL (Inches)		1.27	3.77	0.16

MESSAGES

Irrigation rules change during Eastern Standard Time. Businesses should irrigate only on Tuesdays. For irrigation tips and water-saving ideas visit gru.com/savewater.

SERVICE AGREEMENT: Use or consumption of services rendered by this City shall constitute an agreement by the consumer with the City to abide by the rules of the City with regards to its utility service, including, but not limited to prevailing ordinances and policies of this City and its departments.

RETURN THIS PAYMENT STUB WITH THE PAYMENT FOR PROPER CREDIT



Gainesville Regional Utilities
301 S.E. 4th Avenue
Gainesville FL 32601

Account Number: 2500-0764-6921
Total Payment Enclosed: \$ _____
TOTAL AMOUNT DUE \$ 487.37

Sign up for eBill, GRU's free online paperless billing service, at gru.com/ebill

Pay past due balance immediately to avoid possible service interruption

004597 000000299



C/O RICK MONTEJANO
FINLEY WOODS COMMUNITY DEVELOPMENT
3501 QUADRANGLE BLVD STE 270
ORLANDO FL 32817-8329



GAINESVILLE REGIONAL UTILITIES
P.O. BOX 147051
GAINESVILLE FL 32614-7051





Gainesville Regional Utilities
301 S.E. 4th Avenue
Gainesville FL 32601

Account: 2500-0764-7022
Bill Date: 11/20/2025

FINLEY WOODS COMMUNITY DEVELOPMENT
5830 SW 46TH DR
GAINESVILLE FL 32608

510000363681
ROUTE: 191932
NRES

Cash Security Deposit on File is \$220.00

SUMMARY OF SERVICES

UTILITIES (See reverse for details about your utility charges.)

Water \$9.60
Total Utility Charge \$9.60

TAXES AND SURCHARGES

City of Gainesville Utility Tax \$0.96
Total Taxes and Surcharges \$0.96

TOTAL CURRENT MONTH CHARGES \$10.56

ADJUSTMENTS & SERVICE CHARGES

Late Fee \$1.00
Security Deposit Interest -\$0.48
TOTAL ADJUSTMENTS & SERVICE CHARGES \$0.52

PREVIOUS BILL ACTIVITY

Previous Balance \$36.36
BALANCE FORWARD \$36.36

ACCOUNT SUMMARY

Current Month Charges: \$10.56 **DUE BY 12/11/2025**
Adjustments & Service Charges: \$0.52
Balance Forward: \$36.36 **DUE IMMEDIATELY**

TOTAL AMOUNT DUE \$47.44

A 1.5% late fee will be charged for new charges not paid by your due date. Service disconnection may result from past due balances.

AVERAGE DAILY CONSUMPTION

Service	Meter	This Month	Last Month	Last Year
WATER	22048833	0.00	0.00	1.34
AVERAGE TEMPERATURE (High/Low)		78/53	87/68	80/60
MONTHLY RAINFALL (Inches)		1.27	3.77	0.16

MESSAGES

Irrigation rules change during Eastern Standard Time. Businesses should irrigate only on Tuesdays. For irrigation tips and water-saving ideas visit gru.com/savewater.

SERVICE AGREEMENT: Use or consumption of services rendered by this City shall constitute an agreement by the consumer with the City to abide by the rules of the City with regards to its utility service, including, but not limited to prevailing ordinances and policies of this City and its departments.

RETURN THIS PAYMENT STUB WITH THE PAYMENT FOR PROPER CREDIT



Gainesville Regional Utilities
301 S.E. 4th Avenue
Gainesville FL 32601

Account Number: 2500-0764-7022
Total Payment Enclosed: \$ _____
TOTAL AMOUNT DUE \$ 47.44

Sign up for eBill, GRU's free online paperless billing service, at gru.com/ebill

Pay past due balance immediately to avoid possible service interruption

004598 000000299



C/O RICK MONTEJANO
FINLEY WOODS COMMUNITY DEVELOPMENT
3501 QUADRANGLE BLVD STE 270
ORLANDO FL 32817-8329



GAINESVILLE REGIONAL UTILITIES
P.O. BOX 147051
GAINESVILLE FL 32614-7051



WATER AND WASTEWATER SERVICE DETAILS

Meter Number	Meter Read Dates Previous	Meter Read Dates Present	Meter Read Type	Days of Service	Meter Readings Previous	Meter Readings Present	Meter Multiplier	Water Consumption	Wastewater Consumption	Next Meter Read on or About
22048833	10/15/2025	11/13/2025	ACTUAL	30	846	846	1.00000	0 kGals	N/A	12/12/2025

Description	Usage	Rate	Amount Billed
WATER CUSTOMER CHARGE		\$9.60	\$9.60
WATER USE	0	\$0.0000	\$0.00
GAINESVILLE WATER UTIL TAX			\$0.96
Total for Water and Wastewater Service Details			\$10.56

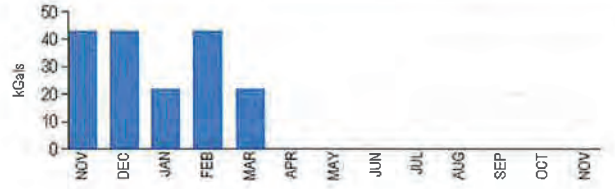

Pay Cash using the payment slip below at a local convenient location in your neighborhood. Check on-line for additional retail establishments.

Customer Inquiries

Customer Service	(352) 334-3434	Stormwater Service	(352) 334-5070
Emergency or Outages	(352) 334-2871	Solid Waste Service	(352) 334-2330

Payment Information

Make checks payable to GRU; return stub and check to: P.O. Box 147051, Gainesville, FL 32614-7051. You may also pay your bill online, by phone at 352-393-6886 or at a convenient location in your neighborhood. Visit www.gru.com for details.

Lobby 8 AM - 5 PM: M, T, Th, F and 9 AM - 5 PM: W
 Drive-thru 7:30 AM - 6 PM: M - F

Night depository payments will be posted the next business day if received after 3:30 p.m.

HOW TO READ YOUR METER

Read the dials from left to right (A-E). If the dial hand is between two numbers, use the lower number.

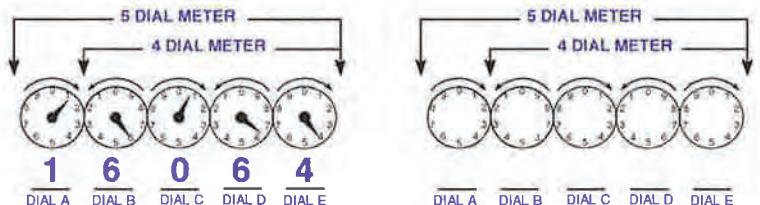

PAY WITH CASH PAY YOUR GAINESVILLE REGIONAL UTILITIES BILL WITH CASH AT PARTICIPATING RETAILERS. **KUBRA EZ-PAY**

Bring this barcode with you to make a payment.

RETAILER INSTRUCTIONS:

- 1 SCAN the customer's barcode.
- 2 The register will **PROMPT** you to enter an amount.
- 3 **ENTER** the amount the customer wants to pay.
- 4 **COLLECT** the desired cash amount (and fee, if applicable).
- 5 When the transaction is **COMPLETE** hand customer the receipt.

For Customer Assistance, call (352) 334-3434.

By accepting or using this barcode to make a payment, you agree to the full terms and conditions, available at www.gru.com.

After successful payment using this barcode, you may receive your full detailed e-receipt at ru@direct.gaincity.org.

799366003990006371683644047913

A \$1.50 fee will be added.



ACCOUNT NAME		ACCOUNT #	INV DATE
Finley Woods CDD		624816	11/30/25
INVOICE #	INVOICE PERIOD	CURRENT INVOICE TOTAL	
0007455770	Nov 1- Nov 30, 2025	\$154.52	
PREPAY (Memo Info)	UNAPPLIED (included in amt due)	TOTAL CASH AMT DUE*	
\$0.00	\$0.00	\$154.52	

BILLING ACCOUNT NAME AND ADDRESS	PAYMENT DUE DATE: DECEMBER 31, 2025
Finley Woods CDD 3501 Quadrangle BLVD # 270 Orlando, FL 32817-8329	Legal Entity: Gannett Media Corp. Terms and Conditions: Past due accounts are subject to interest at the rate of 18% per annum or the maximum legal rate (whichever is less). Advertiser claims for a credit related to rates incorrectly invoiced or paid must be submitted in writing to Publisher within 30 days of the invoice date or the claim will be waived. Any credit towards future advertising must be used within 30 days of issuance or the credit will be forfeited. All funds payable in US dollars.

BILLING INQUIRIES/ADDRESS CHANGES 1-877-736-7612 or smb@ccc.gannett.com **FEDERAL ID** 47-2390983

Save A Tree! Gannett is going paperless. Enjoy the convenience of accessing your billing information anytime and pay online. To avoid missing an invoice, sign up today by going to <https://gcil.my.site.com/financialservicesportal/s/>.

Date	Description	Amount
11/1/25	Balance Forward	\$156.98
11/20/25	PAYMENT - THANK YOU	-\$156.98

Package Advertising:

Start-End Date	Order Number	Product	Description	PO Number	Package Cost
11/5/25	11800721	GAI Gainesville Sun	RE: Finley Woods CDD BOS Notice to be published on November 5, 2025		\$154.52

As an incentive for customers, we provide a discount off the total invoice cost equal to the 3.99% service fee if you pay with Cash/Check/ACH. Pay by Cash/Check/ACH and Save!

Total Cash Amount Due	\$154.52
Service Fee 3.99%	\$6.17
*Cash/Check/ACH Discount	-\$6.17
*Payment Amount by Cash/Check/ACH	\$154.52
Payment Amount by Credit Card	\$160.69

PLEASE DETACH AND RETURN THIS PORTION WITH YOUR PAYMENT

ACCOUNT NAME		ACCOUNT NUMBER		INVOICE NUMBER		AMOUNT PAID
Finley Woods CDD		624816		0007455770		
CURRENT DUE	30 DAYS PAST DUE	60 DAYS PAST DUE	90 DAYS PAST DUE	120+ DAYS PAST DUE	UNAPPLIED PAYMENTS	TOTAL CASH AMT DUE*
\$154.52	\$0.00	\$0.00	\$0.00	\$0.00	\$0.00	\$154.52
REMITTANCE ADDRESS (Include Account# & Invoice# on check)				TO PAY BY PHONE PLEASE CALL:		TOTAL CREDIT CARD AMT DUE
Gannett Florida LocaliQ PO Box 631244 Cincinnati, OH 45263-1244				1-877-736-7612		\$160.69
				To sign up for E-mailed invoices and online payments please go to https://gcil.my.site.com/financialservicesportal/s/		

00006248160000000000000074557700001545267170

KUTAK ROCK LLP

TALLAHASSEE, FLORIDA

Telephone 404-222-4600

Facsimile 404-222-4654

Federal ID 47-0597598

December 4, 2025

Check Remit To:

Kutak Rock LLP

PO Box 30057

Omaha, NE 68103-1157

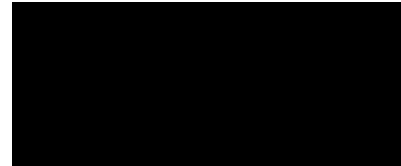

Reference: Invoice No. 3669599

Client Matter No. 8323-1

Notification Email: eftgroup@kutakrock.com

Ms. Jane Gaarlandt
Finley Woods CDD
PFM Group Consulting, LLC
12051 Corporate Boulevard
Orlando, FL 32817

Invoice No. 3669599

8323-1

Re: General Counsel

For Professional Legal Services Rendered

10/09/25	J. Gillis	0.10	16.00	Receive and review Florida DEO special district update form
10/17/25	M. Rigoni	0.20	56.00	Confer with Rogers regarding procurement options
10/21/25	J. Earlywine	0.90	324.00	Conference call regarding amenity operations and related items; follow-up regarding conflict question
10/27/25	P. O'Bryant	3.20	896.00	Review conflict of interest and voting conflict issues
10/27/25	M. Rigoni	0.70	196.00	Analyze voting conflict matters and confer with O'Bryant and Earlywine
10/29/25	M. Rigoni	0.30	84.00	Review agenda; follow up with Young, Junkin, and Patterson regarding outstanding district business; confer with Kerr and Rogers regarding meeting schedule
10/31/25	P. O'Bryant	2.70	756.00	Review conflict of interest and voting conflict issues

KUTAK ROCK LLP

Finley Woods CDD
December 4, 2025
Client Matter No. 8323-1
Invoice No. 3669599
Page 2

TOTAL HOURS	8.10	
TOTAL FOR SERVICES RENDERED		\$2,328.00
TOTAL CURRENT AMOUNT DUE		\$2,328.00
UNPAID INVOICES:		
September 18, 2025	Invoice No. 3626418	3,287.21
October 31, 2025	Invoice No. 3644788	3,306.50
October 31, 2025	Invoice No. 3644791	756.00
TOTAL DUE		<u>\$9,677.71</u>

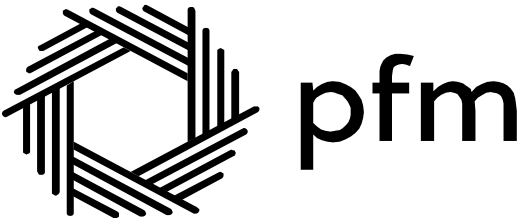

Date	Invoice Number
December 1, 2025	DM-12-2025-21
Payment Terms	Due Date
Upon Receipt	December 1, 2025

Bill To:
Finley Woods CDD
c/o PFM Group Consulting District Accounting
Department
3501 Quadrangle Blvd., Suite 270
Orlando, FL 32817
United States of America

Company Address:
1735 Market Street
42nd Floor
Philadelphia, PA 19103
+1 (215) 5676100

Remittance Options:

Via Mail:

PFM Group Consulting LLC
PO Box 65126
Baltimore, MD 21264-5126
United States of America

RE: District Management Fee: December 2025

Professional Fees	\$2,083.33
Total Amount Due	\$2,083.33

**FINLEY WOODS
COMMUNITY DEVELOPMENT DISTRICT**

Funding Request No. 98
1/7/2026

Invoice No	Supplier	Invoice Date	Property	Invoice Amount
0002	Alex Michael Landscaping LLC (FINLEY)	11/16/2025	Finley Woods CDD	4,500.00
46921-122325	Gainesville Regional Utilities (FINLEY)	12/23/2025	Finley Woods CDD	750.96
46820-122325	Gainesville Regional Utilities (FINLEY)	12/23/2025	Finley Woods CDD	21.10
47022-122325	Gainesville Regional Utilities (FINLEY)	12/23/2025	Finley Woods CDD	18.22
0007504618	Gannett Florida LocaliQ (FINLEY)	12/31/2025	Finley Woods CDD	179.12
3686202	Kutak Rock LLP (FINLEY)	01/06/2026	Finley Woods CDD	2,372.00
139767	PFM Group Consulting LLC (FINLEY)	12/15/2025	Finley Woods CDD	1,250.00
8020	VGlobalTech (FINLEY)	12/01/2025	Finley Woods CDD	145.00
7987	VGlobalTech (FINLEY)	12/01/2025	Finley Woods CDD	300.00
			Total:	9,536.40

Board Member

Please Return To:
Finley Woods CDD
c/o PFM Group Consulting LLC
3501 Quadrangle Boulevard, Ste. 270
Orlando, FL 32817

INVOICE

Alex Michael Landscaping LLC
PO Box 1564
Ocala, FL 34478-1564

alexmichaellandscaping@gmail.com
+1 (352) 208-2652



Bill to
The Boyd Group

Invoice details

Invoice no.: 0002
Terms: Net 30
Invoice date: 11/16/2025
Due date: 12/16/2025

#	Product or service	Description	Qty	Rate	Amount
1.	NOTES	Finley Woods Northeast DRA			
2.	Clean Up	Clean Up - Perimeter and slopes of retention pond to be completely weed eaten, mowed, and any brush or piles of grass clippings to be removed. - Leaving the pond bottom untouched.	1	\$4,500.00	\$4,500.00
3.	CUSTOMER ACCEPTANCE	ACCEPTANCE OF ESTIMATE - The above specifications, conditions, and prices, are satisfactory to the Customer, and hereby accepted. ALEX MICHAEL LANDSCAPING LLC is authorized to do the work as specified. Also, this transaction is governed by the Terms and Conditions of ALEX MICHAEL LANDSCAPING LLC, which have been provided to the Customer.			\$0.00

Total **\$4,500.00**

Overdue 12/16/2025

Ways to pay



[View and pay](#)



Gainesville Regional Utilities
301 S.E. 4th Avenue
Gainesville FL 32601

Account: 2500-0764-6921
Bill Date: 12/23/2025

FINLEY WOODS COMMUNITY DEVELOPMENT

6085 SW 46TH DR
GAINESVILLE FL 32608

509000373864
ROUTE: 191932
NRES

Cash Security Deposit on File is \$220.00

SUMMARY OF SERVICES

UTILITIES (See reverse for details about your utility charges.)

Water \$404.40
Total Utility Charge \$404.40

TOTAL CURRENT MONTH CHARGES \$404.40

ADJUSTMENTS & SERVICE CHARGES

Security Deposit Interest -\$0.28
TOTAL ADJUSTMENTS & SERVICE CHARGES -\$0.28

PREVIOUS BILL ACTIVITY

Previous Balance \$445.24
Payment Amount (Date: 12/16/2025) -\$98.40
BALANCE FORWARD \$346.84

ACCOUNT SUMMARY

Current Month Charges: \$404.40
Adjustments & Service Charges: -\$0.28
Balance Forward: \$346.84

TOTAL AMOUNT DUE \$750.96 DUE BY 01/13/2026

A 1.5% late fee will be charged for new charges not paid by your due date. Service disconnection may result from past due balances.

AVERAGE DAILY CONSUMPTION

Service	Meter	This Month	Last Month	Last Year
WATER	22048685	2.90	2.43	0.00
AVERAGE TEMPERATURE (High/Low)		75/51	78/53	71/44
MONTHLY RAINFALL (Inches)		1.63	1.27	0.19

MESSAGES

Energy savings tip: Timers can help you control your lights when your business is closed. Don't leave holiday lights on overnight. It's safest to turn them off when you leave the premises. Get more tips at gru.com/saveenergybiz.

SERVICE AGREEMENT: Use or consumption of services rendered by this City shall constitute an agreement by the consumer with the City to abide by the rules of the City with regards to its utility service, including, but not limited to prevailing ordinances and policies of this City and its departments.

RETURN THIS PAYMENT STUB WITH THE PAYMENT FOR PROPER CREDIT



Gainesville Regional Utilities
301 S.E. 4th Avenue
Gainesville FL 32601

Account Number: 2500-0764-6921
Total Payment Enclosed: \$ _____
TOTAL AMOUNT DUE \$ 750.96

Current month charges due on 01/13/2026

Sign up for eBill, GRU's free online paperless billing service, at gru.com/ebill

004527 000000299



C/O RICK MONTEJANO
FINLEY WOODS COMMUNITY DEVELOPMENT
3501 QUADRANGLE BLVD STE 270
ORLANDO FL 32817-8329



GAINESVILLE REGIONAL UTILITIES
P.O. BOX 147051
GAINESVILLE FL 32614-7051

WATER AND WASTEWATER SERVICE DETAILS

Meter Number	Meter Read Dates Previous	Meter Read Dates Present	Meter Read Type	Days of Service	Meter Readings Previous	Meter Readings Present	Meter Multiplier	Water Consumption	Wastewater Consumption	Next Meter Read on or About
22048685	11/14/2025	12/12/2025	ACTUAL	29	898	982	1.00000	84 kGals	N/A	01/13/2026

Description	Usage	Rate	Amount Billed
WATER CUSTOMER CHARGE		\$9.60	\$9.60
WATER USE	84	\$4.7000	\$394.80
Total for Water and Wastewater Service Details			\$404.40

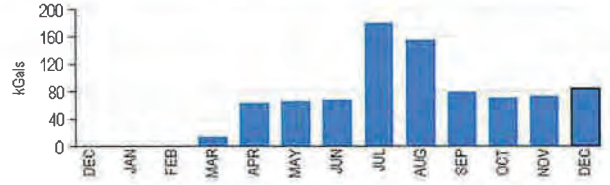

Pay Cash using the payment slip below at a local convenient location in your neighborhood. Check on-line for additional retail establishments.

Customer Inquiries

Customer Service	(352) 334-3434	Stormwater Service	(352) 334-5070
Emergency or Outages	(352) 334-2871	Solid Waste Service	(352) 334-2330

Payment Information

Make checks payable to GRU; return stub and check to: P.O. Box 147051, Gainesville, FL 32614-7051. You may also pay your bill online, by phone at 352-393-6886 or at a convenient location in your neighborhood. Visit www.gru.com for details.

Lobby8 AM - 5 PM: M, T, Th, F and 9 AM - 5 PM: S
 Drive-thru7:30 AM - 6 PM: M - F

Night depository payments will be posted the next business day if received after 3:30 p.m.

HOW TO READ YOUR METER

Read the dials from left to right (A-E). If the dial hand is between two numbers, use the lower number.

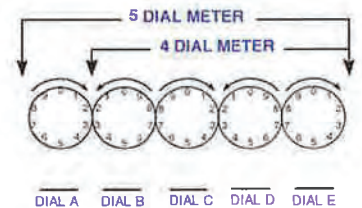
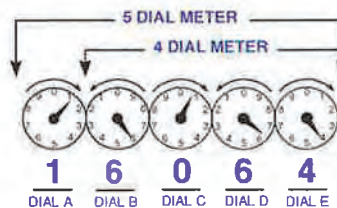

PAY WITH CASH PAY YOUR GAINESVILLE REGIONAL UTILITIES BILL WITH CASH AT PARTICIPATING RETAILERS

Bring this barcode with you to make a payment.

RETAILER INSTRUCTIONS:

- 1 SCAN the customer's barcode
- 2 The register will PROMPT you to enter an amount
- 3 ENTER the amount the customer wants to pay
- 4 COLLECT the desired cash amount (and fee, if applicable)
- 5 When the transaction is COMPLETE hand customer the receipt.

For Customer Assistance, call (352) 334-3434.

By accepting or using this barcode to make a payment, you agree to the full terms and conditions, available at www.gru.com or upon request. After successful payment using this barcode, you may retrieve your full details receipt at www.gru.com.

Participating Retailers: DOLLAR GENERAL, FAMILY DOLLAR, Walgreens, Walmart, CVS, TA, etc.

Barcode: 79936600399006371683644047905

A \$1.50 fee will be added.



Gainesville Regional Utilities
301 S.E. 4th Avenue
Gainesville FL 32601

Account: 2500-0764-6820
Bill Date: 12/23/2025

FINLEY WOODS COMMUNITY DEVELOPMENT

4448 SW 59TH PL
GAINESVILLE FL 32608

509000373863
ROUTE: 191932
NRES

Cash Security Deposit on File is \$220.00

ACCOUNT SUMMARY

Current Month Charges: \$10.56
Adjustments & Service Charges: -\$0.28
Balance Forward: \$10.82

TOTAL AMOUNT DUE \$21.10 DUE BY 01/13/2026

A 1.5% late fee will be charged for new charges not paid by your due date. Service disconnection may result from past due balances.

SUMMARY OF SERVICES

UTILITIES (See reverse for details about your utility charges.)

Water \$9.60
Total Utility Charge \$9.60

TAXES AND SURCHARGES

City of Gainesville Utility Tax \$0.96
Total Taxes and Surcharges \$0.96

TOTAL CURRENT MONTH CHARGES \$10.56

ADJUSTMENTS & SERVICE CHARGES

Security Deposit Interest -\$0.28
TOTAL ADJUSTMENTS & SERVICE CHARGES -\$0.28

PREVIOUS BILL ACTIVITY

Previous Balance \$47.18
Payment Amount (Date: 12/16/2025) -\$36.36
BALANCE FORWARD \$10.82

AVERAGE DAILY CONSUMPTION

Service	Meter	This Month	Last Month	Last Year
WATER	22048689	0.00	0.00	0.00
AVERAGE TEMPERATURE (High/Low)		75/51	78/53	71/44
MONTHLY RAINFALL (Inches)		1.63	1.27	0.19

MESSAGES

Energy savings tip: Timers can help you control your lights when your business is closed. Don't leave holiday lights on overnight. It's safest to turn them off when you leave the premises. Get more tips at gru.com/saveenergybiz.

SERVICE AGREEMENT: Use or consumption of services rendered by this City shall constitute an agreement by the consumer with the City to abide by the rules of the City with regards to its utility service, including, but not limited to prevailing ordinances and policies of this City and its departments.

RETURN THIS PAYMENT STUB WITH THE PAYMENT FOR PROPER CREDIT



Gainesville Regional Utilities
301 S.E. 4th Avenue
Gainesville FL 32601

Account Number: 2500-0764-6820
Total Payment Enclosed: \$
TOTAL AMOUNT DUE \$ 21.10

Sign up for eBill, GRU's free online paperless billing service, at gru.com/ebill

004526 000000299



C/O RICK MONTEJANO
FINLEY WOODS COMMUNITY DEVELOPMENT
3501 QUADRANGLE BLVD STE 270
ORLANDO FL 32817-8329



GAINESVILLE REGIONAL UTILITIES
P.O. BOX 147051
GAINESVILLE FL 32614-7051

WATER AND WASTEWATER SERVICE DETAILS

Meter Number	Meter Read Dates		Meter Read Type	Days of Service	Meter Readings		Meter Multiplier	Water Consumption	Wastewater Consumption	Next Meter Read on or About
	Previous	Present			Previous	Present				
22048689	11/14/2025	12/12/2025	ACTUAL	29	737	737	1.00000	0 kGals	N/A	01/13/2026

Description	Usage	Rate	Amount Billed
WATER CUSTOMER CHARGE		\$9.60	\$9.60
WATER USE	0	\$0.0000	\$0.00
GAINESVILLE WATER UTIL TAX			\$0.96
Total for Water and Wastewater Service Details			\$10.56

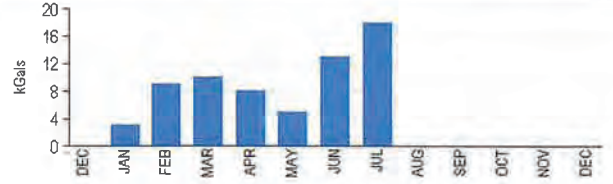

Pay Cash using the payment slip below at a local convenient location in your neighborhood. Check on-line for additional retail establishments.

Customer Inquiries

Customer Service	(352) 334-3434	Stormwater Service	(352) 334-5070
Emergency or Outages	(352) 334-2871	Solid Waste Service	(352) 334-2330

Payment Information

Make checks payable to GRU; return stub and check to: P.O. Box 147051, Gainesville, FL 32614-7051. You may also pay your bill online, by phone at 352-393-6886 or at a convenient location in your neighborhood. Visit www.gru.com for details.

Lobby 8 AM - 5 PM: M, T, Th, F and 9 AM - 5 PM: W
 Drive-thru 7:30 AM - 6 PM: M - F

Night depository payments will be posted the next business day if received after 3:30 p.m.

HOW TO READ YOUR METER

Read the dials from left to right (A-E). If the dial hand is between two numbers, use the lower number.

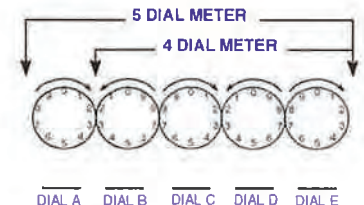
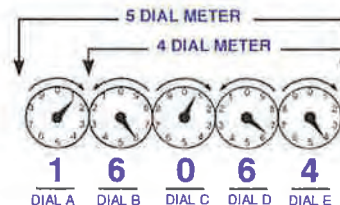

PAY WITH CASH PAY YOUR GAINESVILLE REGIONAL UTILITIES BILL WITH CASH AT PARTICIPATING RETAILERS. *Participating retailers are located throughout the city.*

Bring this barcode with you to make a payment.

RETAILER INSTRUCTIONS:

- 1 SCAN the customer's barcode
- 2 The register will PROMPT you to enter an amount
- 3 ENTER the amount the customer wants to pay
- 4 COLLECT the desired cash amount (and fee, if applicable)
- 5 When the transaction is COMPLETE hand customer the receipt

For Customer Assistance, call (352) 334-3434

By accepting or using this barcode to make a payment, you agree to the full terms and conditions, available at www.gru.com

After successful payment using this barcode, you may receive your full payment receipt at www.gru.com

799366003990006371683644047897

A \$1.50 fee will be added

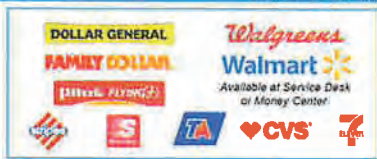



Gainesville Regional Utilities
301 S.E. 4th Avenue
Gainesville FL 32601

Account: 2500-0764-7022
Bill Date: 12/23/2025

FINLEY WOODS COMMUNITY DEVELOPMENT
5830 SW 46TH DR
GAINESVILLE FL 32608

509000373865
ROUTE: 191932
NRES

Cash Security Deposit on File is \$220.00

ACCOUNT SUMMARY

Current Month Charges:	\$9.60
Adjustments & Service Charges:	-\$0.28
Balance Forward:	\$8.90

TOTAL AMOUNT DUE \$18.22 DUE BY 01/13/2026

A 1.5% late fee will be charged for new charges not paid by your due date. Service disconnection may result from past due balances.

SUMMARY OF SERVICES

UTILITIES (See reverse for details about your utility charges.)

Water	\$9.60
Total Utility Charge	\$9.60

TOTAL CURRENT MONTH CHARGES \$9.60

ADJUSTMENTS & SERVICE CHARGES

Security Deposit Interest	-\$0.28
TOTAL ADJUSTMENTS & SERVICE CHARGES	-\$0.28

PREVIOUS BILL ACTIVITY

Previous Balance	\$45.26
Payment Amount (Date: 12/16/2025)	-\$36.36
BALANCE FORWARD	\$8.90

AVERAGE DAILY CONSUMPTION

Service	Meter	This Month	Last Month	Last Year
WATER	22048833	0.00	0.00	1.48
AVERAGE TEMPERATURE (High/Low)		75/51	78/53	71/44
MONTHLY RAINFALL (Inches)		1.63	1.27	0.19

MESSAGES

Energy savings tip: Timers can help you control your lights when your business is closed. Don't leave holiday lights on overnight. It's safest to turn them off when you leave the premises. Get more tips at gru.com/saveenergybiz.

SERVICE AGREEMENT: Use or consumption of services rendered by this City shall constitute an agreement by the consumer with the City to abide by the rules of the City with regards to its utility service, including, but not limited to prevailing ordinances and policies of this City and its departments.

RETURN THIS PAYMENT STUB WITH THE PAYMENT FOR PROPER CREDIT



Gainesville Regional Utilities
301 S.E. 4th Avenue
Gainesville FL 32601

Account Number:	2500-0764-7022
Total Payment Enclosed:	\$ _____
TOTAL AMOUNT DUE	\$ 18.22

Current month charges due on 01/13/2026

Sign up for eBill, GRU's free online paperless billing service, at gru.com/ebill

004528 000000299



C/O RICK MONTEJANO
FINLEY WOODS COMMUNITY DEVELOPMENT
3501 QUADRANGLE BLVD STE 270
ORLANDO FL 32817-8329



GAINESVILLE REGIONAL UTILITIES
P.O. BOX 147051
GAINESVILLE FL 32614-7051

WATER AND WASTEWATER SERVICE DETAILS

Meter Number	Meter Read Dates Previous Present	Meter Read Type	Days of Service	Meter Readings Previous Present	Meter Multiplier	Water Consumption	Wastewater Consumption	Next Meter Read on or About
22048833	11/14/2025 12/12/2025	ACTUAL	29	846 846	1.00000	0 kGals	N/A	01/13/2026
Description		Usage	Rate	Amount Billed				
WATER CUSTOMER CHARGE			\$9.60	\$9.60				
WATER USE		0	\$0.0000	\$0.00				
Total for Water and Wastewater Service Details				\$9.60				

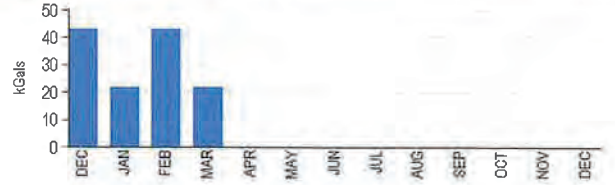

Pay Cash using the payment slip below at a local convenient location in your neighborhood. Check on-line for additional retail establishments.

Customer Inquiries

Customer Service	(352) 334-3434	Stormwater Service	(352) 334-5070
Emergency or Outages	(352) 334-2871	Solid Waste Service	(352) 334-2330

Payment Information

Make checks payable to **GRU**; return stub and check to: P.O. Box 147051, Gainesville, FL 32614-7051. You may also pay your bill online, by phone at 352-393-8886 or at a convenient location in your neighborhood. Visit www.gru.com for details.

Lobby 8 AM - 5 PM: M, T, Th, F and 9 AM - 5 PM: W
 Drive-thru 7:30 AM - 6 PM: M - F

Night depository payments will be posted the next business day if received after 3:30 p.m.

HOW TO READ YOUR METER

Read the dials from left to right (A-E). If the dial hand is between two numbers, use the lower number.

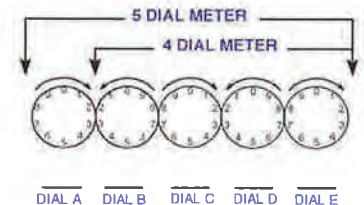
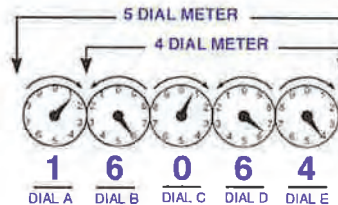

PAY WITH CASH PAY YOUR GAINESVILLE REGIONAL UTILITIES BILL WITH CASH AT PARTICIPATING RETAILERS

Bring this barcode with you to make a payment.

RETAILER INSTRUCTIONS:

- 1 SCAN the customer's barcode
- 2 The register will PROMPT you to enter an amount
- 3 ENTER the amount the customer wants to pay
- 4 COLLECT the desired cash amount (and fee, if applicable)
- 5 When the transactions are COMPLETE, hand customer the receipt

For Customer Assistance, call (352) 334-3434.

By accepting or using this barcode to make a payment, you agree to the full terms and conditions, available at www.gru.com.

After successful payment using this barcode, you may retrieve your full detailed e-receipt at www.gru.com.

799366003990006371683644047913

A \$1-\$5 fee will be added.



ACCOUNT NAME		ACCOUNT #	INV DATE
Finley Woods CDD		624816	12/31/25
INVOICE #	INVOICE PERIOD	CURRENT INVOICE TOTAL	
0007504618	Dec 1- Dec 31, 2025	\$179.12	
PREPAY (Memo Info)	UNAPPLIED (included in amt due)	TOTAL CASH AMT DUE*	
\$0.00	\$0.00	\$179.12	

BILLING ACCOUNT NAME AND ADDRESS	PAYMENT DUE DATE: JANUARY 31, 2026
Finley Woods CDD 3501 Quadrangle BLVD # 270 Orlando, FL 32817-8329	<p>Legal Entity: Gannett Media Corp.</p> <p>Terms and Conditions: Past due accounts are subject to interest at the rate of 18% per annum or the maximum legal rate (whichever is less). Advertiser claims for a credit related to rates incorrectly invoiced or paid must be submitted in writing to Publisher within 30 days of the invoice date or the claim will be waived. Any credit towards future advertising must be used within 30 days of issuance or the credit will be forfeited.</p> <p>All funds payable in US dollars.</p>

BILLING INQUIRIES/ADDRESS CHANGES 1-877-736-7612 or smb@ccc.gannett.com **FEDERAL ID** 47-2390983

Save A Tree! Gannett is going paperless. Enjoy the convenience of accessing your billing information anytime and pay online. To avoid missing an invoice, sign up today by going to <https://gcil.my.site.com/financialservicesportal/s/>.

Date	Description	Amount
12/1/25	Balance Forward	\$154.52
12/29/25	PAYMENT - THANK YOU	-\$154.52

Package Advertising:

Start-End Date	Order Number	Product	Description	PO Number	Package Cost
12/31/25	11918260	GAI Gainesville Sun	BOS MTG 1-8		\$179.12

As an incentive for customers, we provide a discount off the total invoice cost equal to the 3.99% service fee if you pay with Cash/Check/ACH. Pay by Cash/Check/ACH and Save!

Total Cash Amount Due	\$179.12
Service Fee 3.99%	\$7.15
*Cash/Check/ACH Discount	-\$7.15
*Payment Amount by Cash/Check/ACH	\$179.12
Payment Amount by Credit Card	\$186.27

PLEASE DETACH AND RETURN THIS PORTION WITH YOUR PAYMENT

ACCOUNT NAME		ACCOUNT NUMBER		INVOICE NUMBER		AMOUNT PAID
Finley Woods CDD		624816		0007504618		
CURRENT DUE	30 DAYS PAST DUE	60 DAYS PAST DUE	90 DAYS PAST DUE	120+ DAYS PAST DUE	UNAPPLIED PAYMENTS	TOTAL CASH AMT DUE*
\$179.12	\$0.00	\$0.00	\$0.00	\$0.00	\$0.00	\$179.12
REMITTANCE ADDRESS (Include Account# & Invoice# on check)				TO PAY BY PHONE PLEASE CALL:		TOTAL CREDIT CARD AMT DUE
Gannett Florida LocaliQ PO Box 631244 Cincinnati, OH 45263-1244				1-877-736-7612		\$186.27
				To sign up for E-mailed invoices and online payments please go to https://gcil.my.site.com/financialservicesportal/s/		

000062481600000000000000075046180001791267171

KUTAK ROCK LLP

TALLAHASSEE, FLORIDA

Telephone 404-222-4600

Facsimile 404-222-4654

Federal ID 47-0597598

January 6, 2026

Check Remit To:

Kutak Rock LLP

PO Box 30057

Omaha, NE 68103-1157



Reference: Invoice No. 3686202

Client Matter No. 8323-1

Notification Email: eftgroup@kutakrock.com

Ms. Jane Gaarlandt
Finley Woods CDD
PFM Group Consulting, LLC
12051 Corporate Boulevard
Orlando, FL 32817

Invoice No. 3686202

8323-1

Re: General Counsel

For Professional Legal Services Rendered

11/02/25	P. O'Bryant	0.20	56.00	Conduct research and prepare memorandum regarding current law on the open carry of firearms on district property or at meetings
11/03/25	M. Rigoni	0.20	56.00	Confer with Kerr and Gaarlandt regarding meeting items
11/04/25	P. O'Bryant	1.80	504.00	Research conflict of interest and voting conflict issues
11/04/25	M. Rigoni	0.10	28.00	Confer with Gibbs regarding conflicts research
11/05/25	P. O'Bryant	1.40	392.00	Research conflict of interest and voting conflict issues
11/06/25	M. Rigoni	0.60	168.00	Work session with Earlywine and O'Bryant regarding conflicts issues; review draft memorandum and research regarding same
11/10/25	M. Rigoni	0.40	112.00	Confer with Rogers and Earlywine regarding conflict issues
11/12/25	M. Rigoni	0.80	224.00	Confer with Gaarlandt; prepare for and attend Board meeting

KUTAK ROCK LLP

Finley Woods CDD
January 6, 2026
Client Matter No. 8323-1
Invoice No. 3686202
Page 2

11/13/25	J. Gillis	0.10	16.00	Review board members and prepare updates to Capital Conversations e-mail tracking chart
11/13/25	M. Rigoni	0.30	84.00	Revise conflict memo
11/17/25	J. Gillis	0.90	144.00	Follow up from Board meeting; confer with staff regarding Grasshoppers TLC landscape maintenance proposals; draft landscape maintenance agreement with Grasshoppers TLC
11/17/25	M. Rigoni	1.30	364.00	Revise conflicts memo
11/24/25	M. Rigoni	0.80	224.00	Finalize landscape agreement and confer with Kerr

TOTAL HOURS 8.90

TOTAL FOR SERVICES RENDERED \$2,372.00

TOTAL CURRENT AMOUNT DUE \$2,372.00

UNPAID INVOICES:

October 31, 2025 Invoice No. 3644788 3,306.50
October 31, 2025 Invoice No. 3644791 756.00

TOTAL DUE \$6,434.50



Date	Invoice Number
December 15, 2025	139767
Payment Terms	Due Date
Upon Receipt	December 15, 2025

Bill To:
Finley Woods CDD
c/o PFM Group Consulting District Accounting
Department
3501 Quadrangle Blvd., Suite 270
Orlando, FL 32817
United States of America

Company Address:
1735 Market Street
42nd Floor
Philadelphia, PA 19103
+1 (215) 5676100

Remittance Options:

Via Mail:

PFM Group Consulting LLC
PO Box 65126
Baltimore, MD 21264-5126
United States of America

RE: Quarterly Disclosure for the period of 10.01.25 - 12.31.25

Bond Issue 2020

\$1,250.00

Total Amount Due

\$1,250.00

VGlobalTech
636 Fanning Drive
Winter Springs, FL 32708 US
contact@vglobaltech.com
www.vglobaltech.com



INVOICE

BILL TO

Finley Woods CDD
3501 Quadrangle Blvd.,
Suite 270,
Orlando, FL 32817

INVOICE # 8020

DATE 12/01/2025

DUE DATE 12/01/2025

TERMS Due on receipt

DATE	ACTIVITY	QTY	RATE	AMOUNT
	Web Maintenance:ADA Website Maintenance Ongoing website maintenance for ADA and WCAG Compliance	1	145.00	145.00

Please make check payable to VGlobalTech.

BALANCE DUE

\$145.00

Pay invoice

VGlobalTech
636 Fanning Drive
Winter Springs, FL 32708 US
contact@vglobaltech.com
www.vglobaltech.com



INVOICE

BILL TO
Finley Woods CDD
3501 Quadrangle Boulevard,
Suite 270
Orlando, FL 32817 USA

INVOICE # 7987
DATE 12/01/2025
DUE DATE 12/01/2025
TERMS Due on receipt

DATE	ACTIVITY	QTY	RATE	AMOUNT
	Audits:Quarterly ADA & WCAG Audits Quarterly ADA & WCAG Audits for all new content and document conversions for the website.	1	300.00	300.00

Invoice for Quarter 4 ADA Audit.

BALANCE DUE

\$300.00

Please make check payable to VGlobalTech.

Pay invoice

**FINLEY WOODS
COMMUNITY DEVELOPMENT DISTRICT**

Funding Request No. 99
1/14/2026

Invoice No	Supplier	Invoice Date	Property	Invoice Amount
21496	Grasshoppers Total Lawn Care (FINLEY)	01/07/2026	Finley Woods CDD	1,600.00
21497	Grasshoppers Total Lawn Care (FINLEY)	01/07/2026	Finley Woods CDD	1,500.00
494198	NV5 (FINLEY)	01/09/2026	Finley Woods CDD	1,025.00
			Total:	4,125.00

Board Member

Please Return To:
Finley Woods CDD
c/o PFM Group Consulting LLC
3501 Quadrangle Boulevard, Ste. 270
Orlando, FL 32817

Grasshoppers TLC
661 SW 161st Ter
Newberry, FL 32669 USA
+13522194080
grasshopperstlc@gmail.com



INVOICE

BILL TO

Finley Woods Phase 2
5140 SW 62nd Ave.
Gainesville, Fl 32608

INVOICE # 21496
DATE 01/07/2026
DUE DATE 01/22/2026
TERMS Net 15

ACTIVITY	QTY	RATE	AMOUNT
Property Maintenance Monthly service fee to maintain common areas of Finley Woods Phase 2.	1	1,600.00	1,600.00

*This invoice is for services provided
December 2025.

Thank you for the opportunity to help.

BALANCE DUE

\$1,600.00

Pay invoice

Grasshoppers TLC
661 SW 161st Ter
Newberry, FL 32669 USA
+13522194080
grasshopperstlc@gmail.com



INVOICE

BILL TO

Finley Woods Phase 1C
4809 SW 62nd Ave.
Gainesville, Fl. 32608

INVOICE # 21497
DATE 01/07/2026
DUE DATE 01/22/2026
TERMS Net 15

ACTIVITY	QTY	RATE	AMOUNT
Property Maintenance Monthly service fee to maintain common areas of Finley Woods Phase 1C.	1	1,500.00	1,500.00

*This invoice is for services provided
December 2025.

Thank you for the opportunity to help.

BALANCE DUE

\$1,500.00

Pay invoice

Invoice



Federal Tax ID# 27-1979486

Remit checks to:
NV5, Inc.
PO Box 74008680
Chicago, IL 60674-8680

Remit ACH transfer to:
[Redacted]

[Redacted]

Finley Woods CDD
12051 Corporate Boulevard
Orlando, FL 32817

January 09, 2026
Project No: 1510719-0036007.00
Invoice No: 494198
Due Date: February 08, 2026

Project 1510719-0036007.00 Finley Woods CDD
Dec 2025:
Stormwater Pond Inspection For Phase 1C
Inspection Report

Professional Services from November 30, 2025 to December 27, 2025

Professional Personnel

	Hours	Rate	Amount	
Project Coordinator	1.00	85.00	85.00	
Senior Inspector	4.50	120.00	540.00	
Construction PM/CEI Project Admin	2.50	160.00	400.00	
Totals	8.00		1,025.00	
Total Labor				1,025.00
		Total this Invoice		1,025.00

**FINLEY WOODS
COMMUNITY DEVELOPMENT DISTRICT**

Funding Request No. 100
1/28/2026

Invoice No	Supplier	Invoice Date	Property	Invoice Amount
21748	Grasshoppers Total Lawn Care (FINLEY)	01/26/2026	Finley Woods CDD	1,500.00
21752	Grasshoppers Total Lawn Care (FINLEY)	01/26/2026	Finley Woods CDD	1,600.00
DM-01-2026-19	PFM Group Consulting LLC (FINLEY)	01/05/2026	Finley Woods CDD	2,083.33
8110	VGlobalTech (FINLEY)	01/01/2026	Finley Woods CDD	145.00
Total:				5,328.33

Board Member

Please Return To:
Finley Woods CDD
c/o PFM Group Consulting LLC
3501 Quadrangle Boulevard, Ste. 270
Orlando, FL 32817

Grasshoppers TLC
661 SW 161st Ter
Newberry, FL 32669 USA
+13522194080
grasshopperstlc@gmail.com



INVOICE

BILL TO

Finley Woods Phase 1C
4809 SW 62nd Ave.
Gainesville, Fl. 32608

INVOICE # 21748
DATE 01/26/2026
DUE DATE 02/10/2026
TERMS Net 15

ACTIVITY	QTY	RATE	AMOUNT
Property Maintenance Monthly service fee to maintain common areas in Finley Woods Phase 1C.	1	1,500.00	1,500.00

This invoice is for services provided this past month.

Thank you for the opportunity to help.

BALANCE DUE

\$1,500.00

Ways to pay



[View and pay](#)

Grasshoppers TLC
661 SW 161st Ter
Newberry, FL 32669 USA
+13522194080
grasshopperstlc@gmail.com



INVOICE

BILL TO

Finley Woods Phase 2
5140 SW 62nd Ave.
Gainesville, FL 32608

INVOICE # 21752
DATE 01/26/2026
DUE DATE 02/10/2026
TERMS Net 15

ACTIVITY	QTY	RATE	AMOUNT
Property Maintenance Monthly service fee to maintain common areas in Finley Woods Phase 2.	1	1,600.00	1,600.00

This invoice is services provided this past month.

Thank you for the opportunity to help.

BALANCE DUE

\$1,600.00

Ways to pay



[View and pay](#)



Date	Invoice Number
January 5, 2026	DM-01-2026-19
Payment Terms	Due Date
Upon Receipt	January 5, 2026

Bill To:
Finley Woods CDD
c/o PFM Group Consulting District Accounting
Department
3501 Quadrangle Blvd., Suite 270
Orlando, FL 32817
United States of America

Company Address:
1735 Market Street
42nd Floor
Philadelphia, PA 19103
+1 (215) 5676100

Remittance Options:

Via Mail:

PFM Group Consulting LLC
PO Box 65126
Baltimore, MD 21264-5126
United States of America

RE: District Management Fee:January 2026

Professional Fees	\$2,083.33
Total Amount Due	\$2,083.33

VGlobalTech
636 Fanning Drive
Winter Springs, FL 32708 US
contact@vglobaltech.com
www.vglobaltech.com



INVOICE

BILL TO

Finley Woods CDD
3501 Quadrangle Blvd.,
Suite 270,
Orlando, FL 32817

INVOICE # 8110

DATE 01/01/2026

DUE DATE 01/01/2026

TERMS Due on receipt

DATE	ACTIVITY	QTY	RATE	AMOUNT
	Web Maintenance:ADA Website Maintenance Ongoing website maintenance for ADA and WCAG Compliance	1	145.00	145.00

Please make check payable to VGlobalTech.

BALANCE DUE

\$145.00

Pay invoice



Finley Woods Community Development District

Review of Monthly Financials



Finley Woods CDD

December 2025 Financial Package

December 31, 2025

PFM Group Consulting LLC
3501 Quadrangle Blvd
Suite 270
Orlando, FL 32817
(407) 723-5900



Finley Woods CDD
Statement of Financial Position
As of 12/31/2025

	General Fund	Debt Service	Construction	Long Term Debt	Total
<u>Assets</u>					
<u>Current Assets</u>					
General Checking Account	\$154,166.97				\$154,166.97
Assessments Receivable	21,669.99				21,669.99
Deposits	660.00				660.00
Assessment Receivable - Off Roll	37,037.76				37,037.76
Assessments Receivable		\$30,977.94			30,977.94
Due From Other Funds		14,477.36			14,477.36
Debt Service Reserve Series 2020		180,100.00			180,100.00
Revenue Series 2020		153,331.31			153,331.31
Sinking Fund Series 2020		0.02			0.02
Acquisition/Construction Series 2020			\$19,831.93		19,831.93
Total Current Assets	<u>\$213,534.72</u>	<u>\$378,886.63</u>	<u>\$19,831.93</u>	<u>\$0.00</u>	<u>\$612,253.28</u>
<u>Investments</u>					
Amount Available in Debt Service Funds				\$333,431.33	\$333,431.33
Amount To Be Provided				2,436,568.67	2,436,568.67
Total Investments	<u>\$0.00</u>	<u>\$0.00</u>	<u>\$0.00</u>	<u>\$2,770,000.00</u>	<u>\$2,770,000.00</u>
Total Assets	<u>\$213,534.72</u>	<u>\$378,886.63</u>	<u>\$19,831.93</u>	<u>\$2,770,000.00</u>	<u>\$3,382,253.28</u>
<u>Liabilities and Net Assets</u>					
<u>Current Liabilities</u>					
Accounts Payable	\$790.28				\$790.28
Due To Other Funds	14,477.36				14,477.36
Deferred Revenue	21,669.99				21,669.99
Deferred Revenue - Off Roll	37,037.76				37,037.76
Deferred Revenue		\$30,977.94			30,977.94
Retainage Payable			\$240,694.70		240,694.70
Total Current Liabilities	<u>\$73,975.39</u>	<u>\$30,977.94</u>	<u>\$240,694.70</u>	<u>\$0.00</u>	<u>\$345,648.03</u>
<u>Long Term Liabilities</u>					
Revenue Bonds Payable - Long-Term				\$2,770,000.00	\$2,770,000.00
Total Long Term Liabilities	<u>\$0.00</u>	<u>\$0.00</u>	<u>\$0.00</u>	<u>\$2,770,000.00</u>	<u>\$2,770,000.00</u>
Total Liabilities	<u>\$73,975.39</u>	<u>\$30,977.94</u>	<u>\$240,694.70</u>	<u>\$2,770,000.00</u>	<u>\$3,115,648.03</u>
<u>Net Assets</u>					
Net Assets - General Government	\$72,443.32				\$72,443.32
Current Year Net Assets - General Govt	65,436.01				65,436.01
FB - Nonspendable	1,680.00				1,680.00
Net Assets, Unrestricted		\$260,239.71			260,239.71
Current Year Net Assets, Unrestricted		87,668.98			87,668.98
Net Assets, Unrestricted			(\$310,556.13)		(310,556.13)
Current Year Net Assets, Unrestricted			1,893.36		1,893.36
Net Assets - General Government			87,800.00		87,800.00
Total Net Assets	<u>\$139,559.33</u>	<u>\$347,908.69</u>	<u>(\$220,862.77)</u>	<u>\$0.00</u>	<u>\$266,605.25</u>
Total Liabilities and Net Assets	<u>\$213,534.72</u>	<u>\$378,886.63</u>	<u>\$19,831.93</u>	<u>\$2,770,000.00</u>	<u>\$3,382,253.28</u>



Finley Woods CDD
Statement of Activities
As of 12/31/2025

	General Fund	Debt Service	Construction	Long Term Debt	Total
<u>Revenues</u>					
On-Roll Assessments	\$101,117.17				\$101,117.17
Other Income & Other Financing Sources	0.26				0.26
On-Roll Assessments		\$143,886.19			143,886.19
Inter-Fund Group Transfers In		(1,771.77)			(1,771.77)
Inter-Fund Transfers In			\$1,771.77		1,771.77
Total Revenues	<u>\$101,117.43</u>	<u>\$142,114.42</u>	<u>\$1,771.77</u>	<u>\$0.00</u>	<u>\$245,003.62</u>
<u>Expenses</u>					
D&O Insurance	\$3,014.00				\$3,014.00
Trustee Services	1,679.68				1,679.68
Management	6,249.99				6,249.99
Disclosure Agent	1,250.00				1,250.00
District Counsel	2,328.00				2,328.00
Assessment Administration	7,500.00				7,500.00
Postage & Shipping	1.48				1.48
Legal Advertising	311.50				311.50
Web Site Maintenance	435.00				435.00
Dues, Licenses, and Fees	175.00				175.00
Irrigation	1,372.53				1,372.53
General Insurance	3,685.00				3,685.00
Other Insurance	500.00				500.00
Landscaping Maintenance & Material Reserves	4,500.00				4,500.00
Interest Payments -Series 2020		\$55,962.50			55,962.50
Total Expenses	<u>\$36,602.18</u>	<u>\$55,962.50</u>	<u>\$0.00</u>	<u>\$0.00</u>	<u>\$92,564.68</u>
<u>Other Revenues (Expenses) & Gains (Losses)</u>					
Interest Income	\$920.76				\$920.76
Interest Income		\$1,517.06			1,517.06
Interest Income			\$121.59		121.59
Total Other Revenues (Expenses) & Gains (Losses)	<u>\$920.76</u>	<u>\$1,517.06</u>	<u>\$121.59</u>	<u>\$0.00</u>	<u>\$2,559.41</u>
Change In Net Assets	\$65,436.01	\$87,668.98	\$1,893.36	\$0.00	\$154,998.35
Net Assets At Beginning Of Year	<u>\$74,123.32</u>	<u>\$260,239.71</u>	<u>(\$222,756.13)</u>	<u>\$0.00</u>	<u>\$111,606.90</u>
Net Assets At End Of Year	<u><u>\$139,559.33</u></u>	<u><u>\$347,908.69</u></u>	<u><u>(\$220,862.77)</u></u>	<u><u>\$0.00</u></u>	<u><u>\$266,605.25</u></u>



Finley Woods CDD
Budget to Actual
For The Month Ending 12/31/2025

	Year To Date			FY2026 Adopted Budget	Percentage
	Actual	Budget	Variance		
Revenues					
On-Roll Assessments	\$ 101,117.17	\$ 30,721.80	\$ 70,395.37	\$ 122,887.24	82.28%
Off-Roll Assessments	-	9,259.44	(9,259.44)	37,037.76	0.00%
Developer Contributions	-	18,000.00	(18,000.00)	72,000.00	0.00%
Other Income & Other Financing Sources	0.26	-	0.26	-	-
Net Revenues	\$ 101,117.43	\$ 57,981.24	\$ 43,136.19	\$ 231,925.00	0.44%
General & Administrative Expenses					
Supervisor Fees	\$ -	\$ 300.00	\$ (300.00)	\$ 1,200.00	0.00%
D&O Insurance	3,014.00	800.01	2,213.99	3,200.00	94.19%
Other Insurance	500.00	83.34	416.66	500.00	100.00%
Trustee Services	1,679.68	1,100.01	579.67	4,400.00	38.17%
Management	6,249.99	6,249.99	-	25,000.00	25.00%
Engineering	-	2,499.99	(2,499.99)	10,000.00	0.00%
Disclosure Agent	1,250.00	1,250.01	(0.01)	5,000.00	25.00%
District Counsel	2,328.00	6,249.99	(3,921.99)	25,000.00	9.31%
Assessment Administration	7,500.00	1,875.00	5,625.00	7,500.00	100.00%
Reamortization Schedule	-	62.49	(62.49)	250.00	0.00%
Audit	-	943.74	(943.74)	3,775.00	0.00%
Tax Preparation	-	6.24	(6.24)	25.00	0.00%
Postage & Shipping	1.48	62.49	(61.01)	250.00	0.59%
Copies	-	56.25	(56.25)	225.00	0.00%
Legal Advertising	311.50	999.99	(688.49)	4,000.00	7.79%
Miscellaneous	-	249.99	(249.99)	1,000.00	0.00%
Contingency	-	-	-	-	-
Office Supplies	-	12.51	(12.51)	50.00	0.00%
Web Site Maintenance	435.00	735.00	(300.00)	2,940.00	14.80%
Dues, Licenses, and Fees	175.00	104.19	70.81	250.00	70.00%
Total General & Administrative Expenses	\$ 23,444.65	\$ 23,641.23	\$ (196.58)	\$ 94,565.00	24.79%
Maintenance Expenses					
Irrigation	\$ 1,372.53	\$ 2,499.99	\$ (1,127.46)	\$ 10,000.00	13.73%
General Insurance	3,685.00	980.01	2,704.99	3,920.00	94.01%
General Repair & Maintenance	-	1,250.01	(1,250.01)	5,000.00	0.00%
Landscaping Maintenance & Material	3,600.00	10,260.00	(6,660.00)	41,040.00	8.77%
Landscape Maintenance - Phase 3	-	18,000.00	(18,000.00)	72,000.00	0.00%
Reserves	4,500.00	1,350.00	3,150.00	5,400.00	83.33%
Total Maintenance Expenses	\$ 13,157.53	\$ 34,340.01	\$ (21,182.48)	\$ 137,360.00	9.58%
Total Expenses	\$ 36,602.18	\$ 57,981.24	\$ (21,379.06)	\$ 231,925.00	15.78%
Income (Loss) from Operations	\$ 64,515.25	\$ -	\$ 64,515.25	\$ -	
Other Income (Expense)					
Interest Income	\$ 920.76	\$ -	\$ 920.76	\$ -	
Total Other Income (Expense)	\$ 920.76	\$ -	\$ 920.76	\$ -	
Net Income (Loss)	\$ 65,436.01	\$ -	\$ 65,436.01	\$ -	



Finley Woods Community Development District

Staff Reports